

Chapter 2
TMS320C6000 Architectural
Overview

Learning Objectives

- ◆ Describe C6000 CPU architecture.
- ◆ Introduce some basic instructions.
- ◆ Describe the C6000 memory map.
- ◆ Provide an overview of the peripherals.

General DSP System Block Diagram

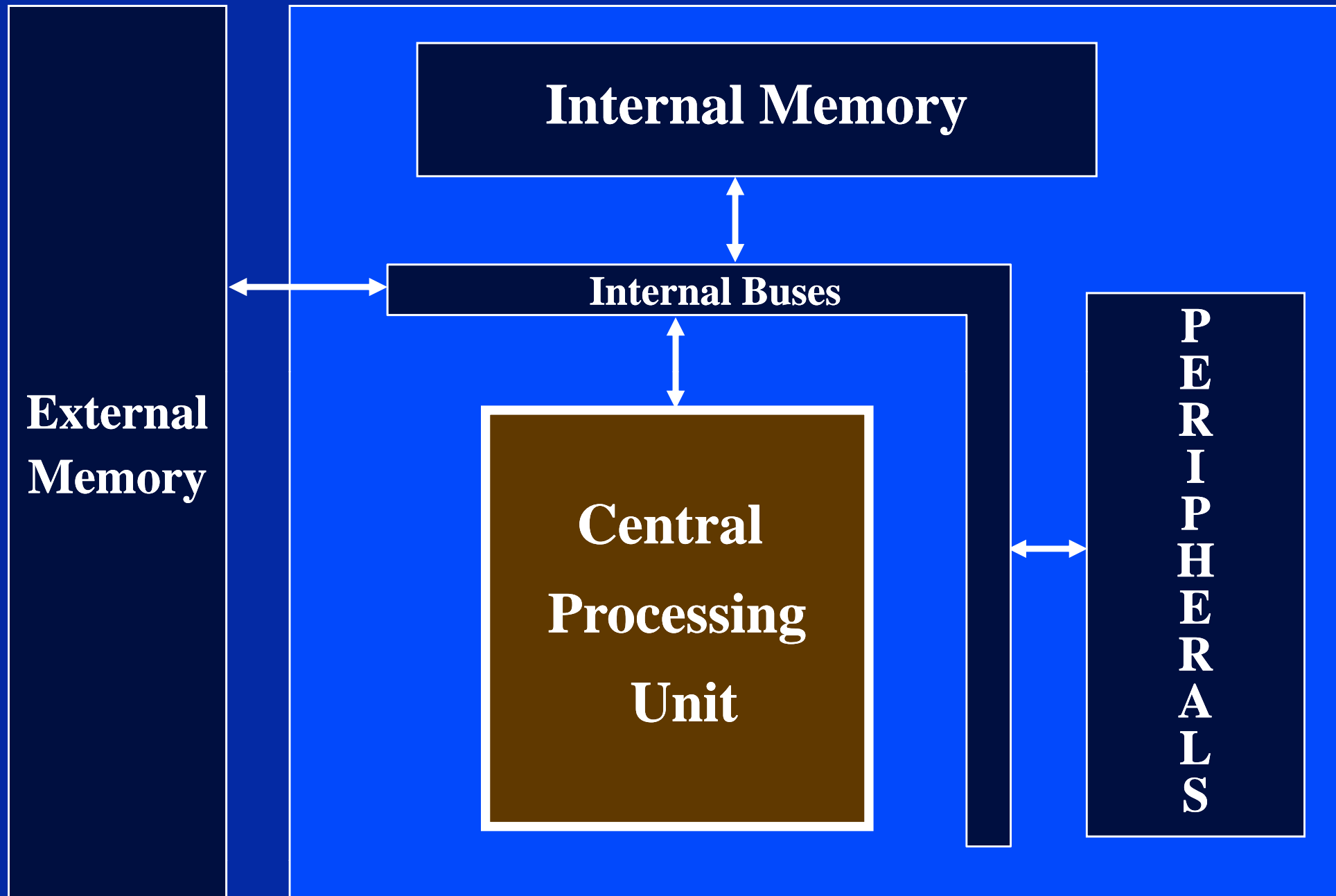

Implementation of Sum of Products (SOP)

It has been shown in Chapter 1 that SOP is the key element for most DSP algorithms.

So let's write the code for this algorithm and at the same time discover the C6000 architecture.

$$Y = \sum_{n=1}^N a_n * x_n$$
$$= a_1 * x_1 + a_2 * x_2 + \dots + a_N * x_N$$

Two basic operations are required for this algorithm.

(1) **Multiplication**

(2) **Addition**

Therefore two basic instructions are required

Implementation of Sum of Products (SOP)

So let's implement the SOP algorithm!

The implementation in this module will be done in assembly.

$$Y = \sum_{n=1}^N a_n * x_n$$
$$= a_1 * x_1 + a_2 * x_2 + \dots + a_N * x_N$$

Two basic operations are required for this algorithm.

(1) **Multiplication**

(2) **Addition**

Therefore two basic instructions are required

Multiply (MPY)

$$Y = \sum_{n=1}^N a_n * x_n$$
$$= a_1 * x_1 + a_2 * x_2 + \dots + a_N * x_N$$

The **multiplication** of a_1 by x_1 is done in assembly by the following instruction:

MPY **a1, x1, Y**

This instruction is performed by a multiplier unit that is called “.M”

Multiply (.M unit)

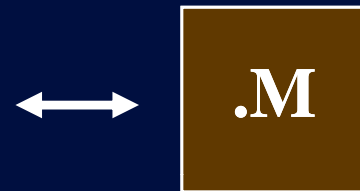

$$Y = \sum_{n=1}^{40} a_n * x_n$$

The . M unit performs multiplications in hardware

MPY .M a1, x1, Y

Note: 16-bit by 16-bit multiplier provides a 32-bit result.

32-bit by 32-bit multiplier provides a 64-bit result.

Addition (.)?

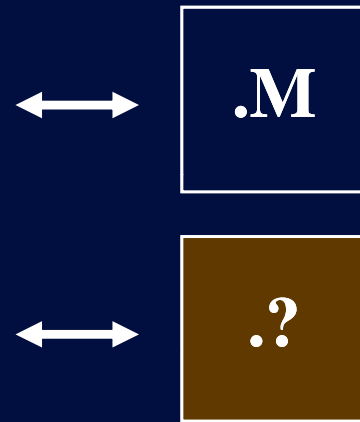

$$Y = \sum_{n=1}^{40} a_n * x_n$$

MPY	.M	a1, x1, prod
ADD	.?	Y, prod, Y

Add (.L unit)

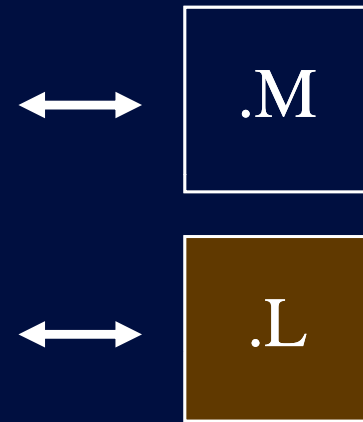

$$Y = \sum_{n=1}^{40} a_n * x_n$$

MPY	.M	a1, x1, prod
ADD	.L	Y, prod, Y

RISC processors such as the C6000 use registers to hold the operands, so lets change this code.

Register File - A

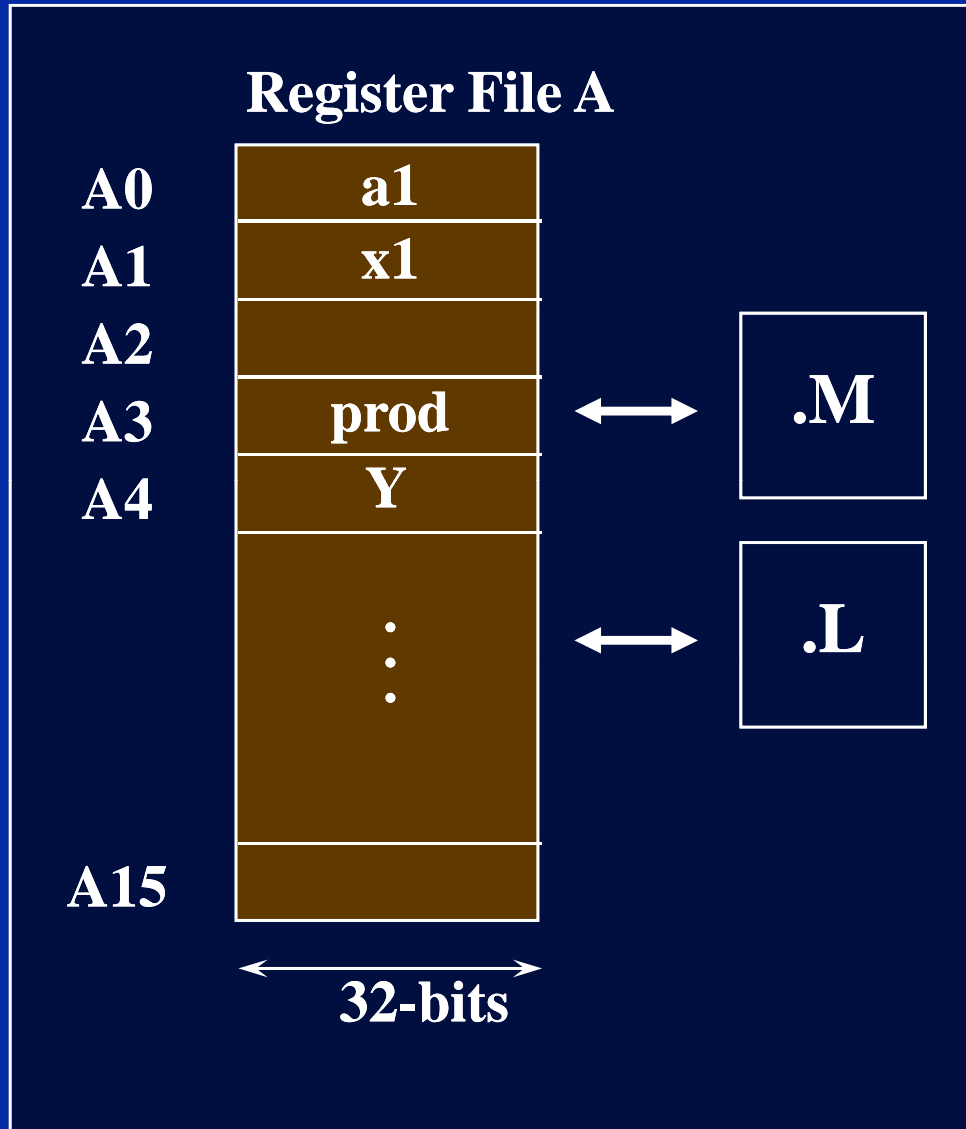

$$Y = \sum_{n=1}^{40} a_n * x_n$$

MPY .M a1, x1, prod
 ADD .L Y, prod, Y

Let us correct this by replacing a, x, prod and Y by the registers as shown above.

Specifying Register Names

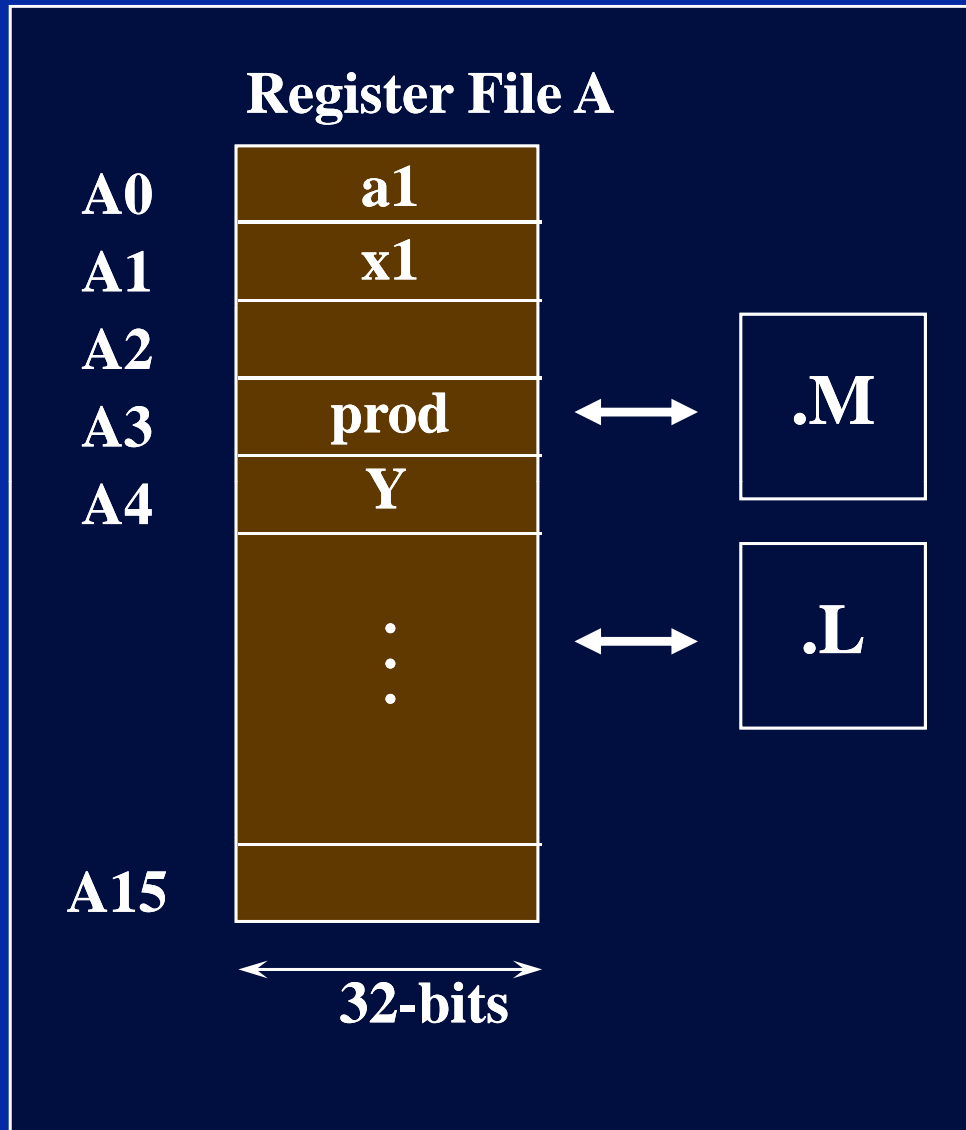

$$Y = \sum_{n=1}^{40} a_n * x_n$$

MPY	.M	A0, A1, A3
ADD	.L	A4, A3, A4

The registers A0, A1, A3 and A4 contain the values to be used by the instructions.

Specifying Register Names

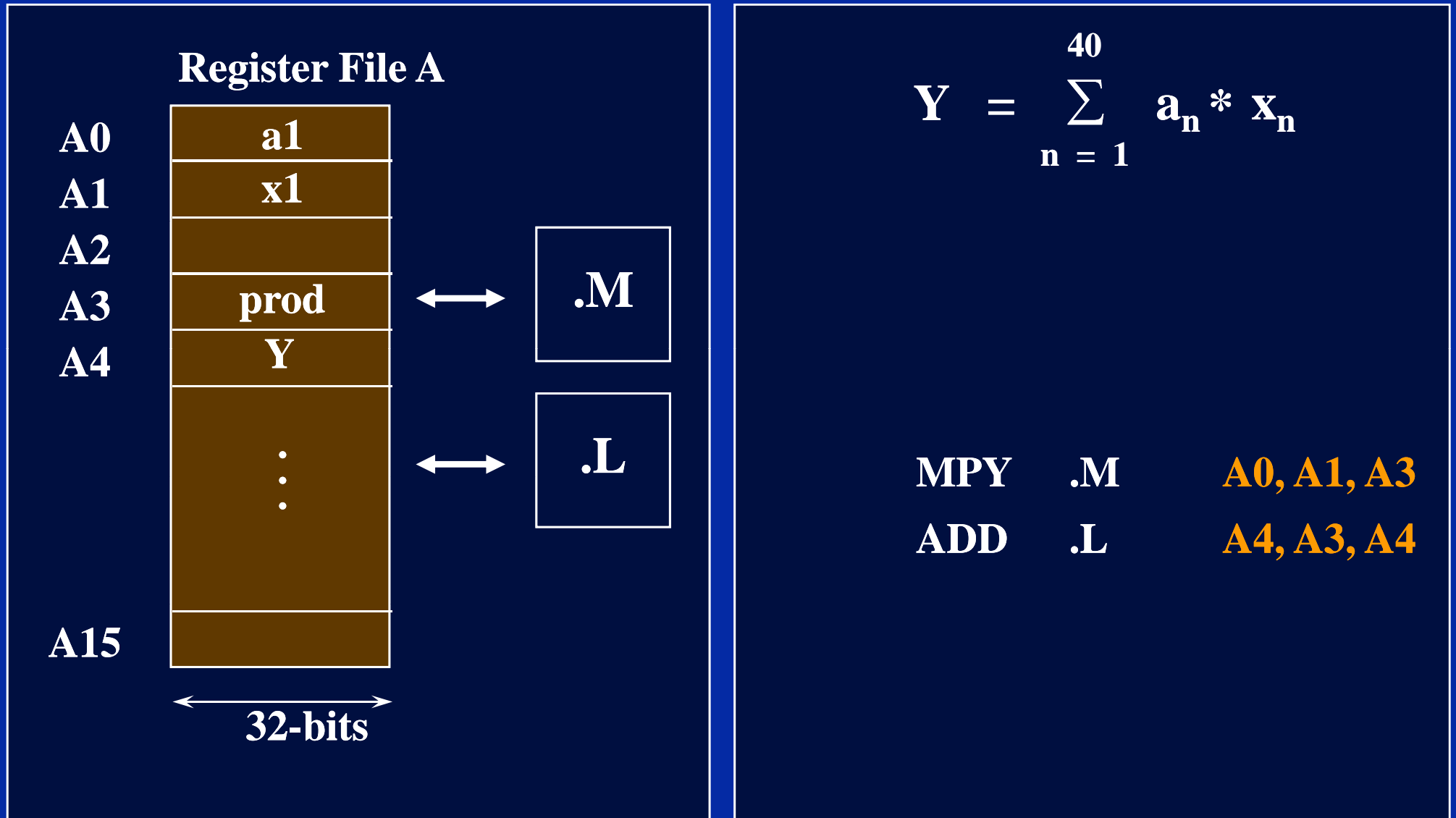

Register File A contains 16 registers (A0 -A15) which are 32-bits wide.

Data loading

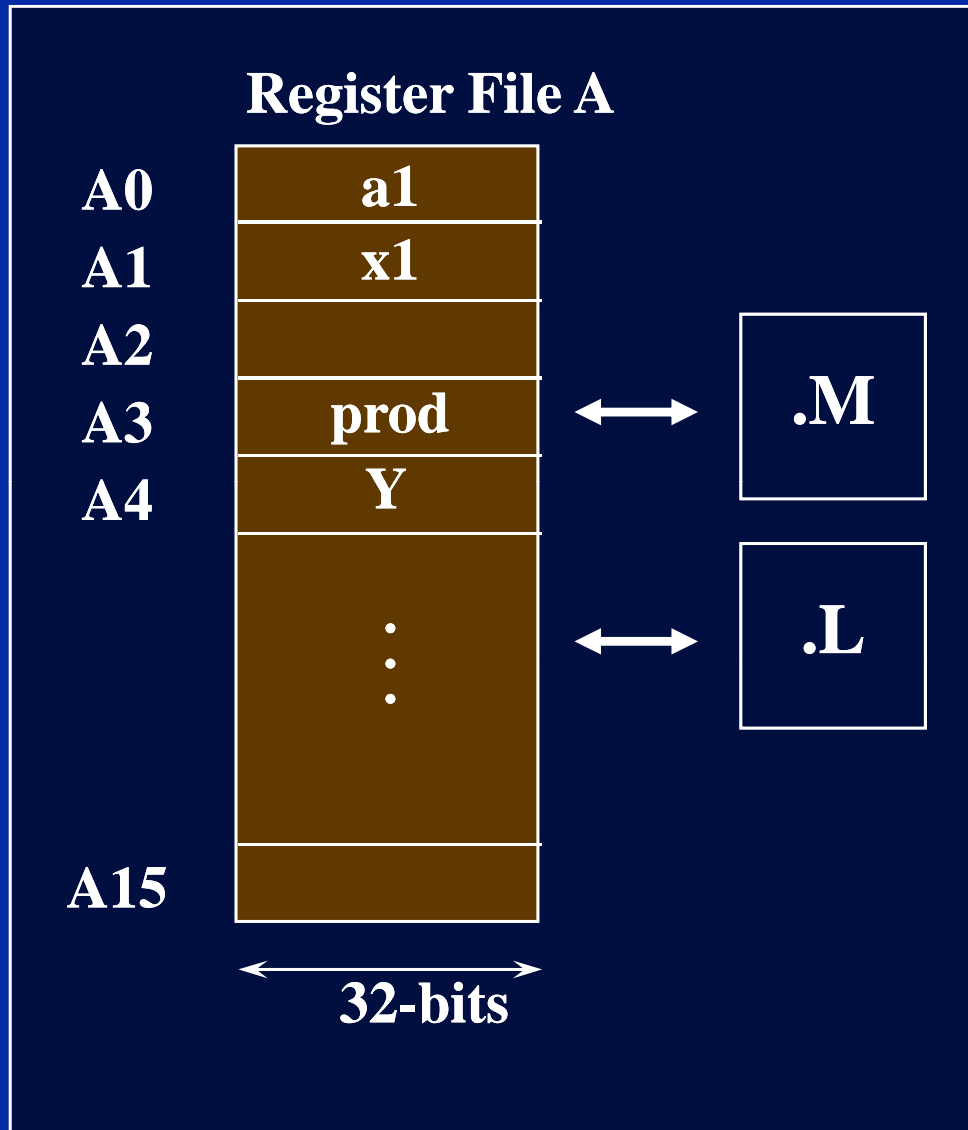

Q: How do we load the operands into the registers?

Load Unit “.D”

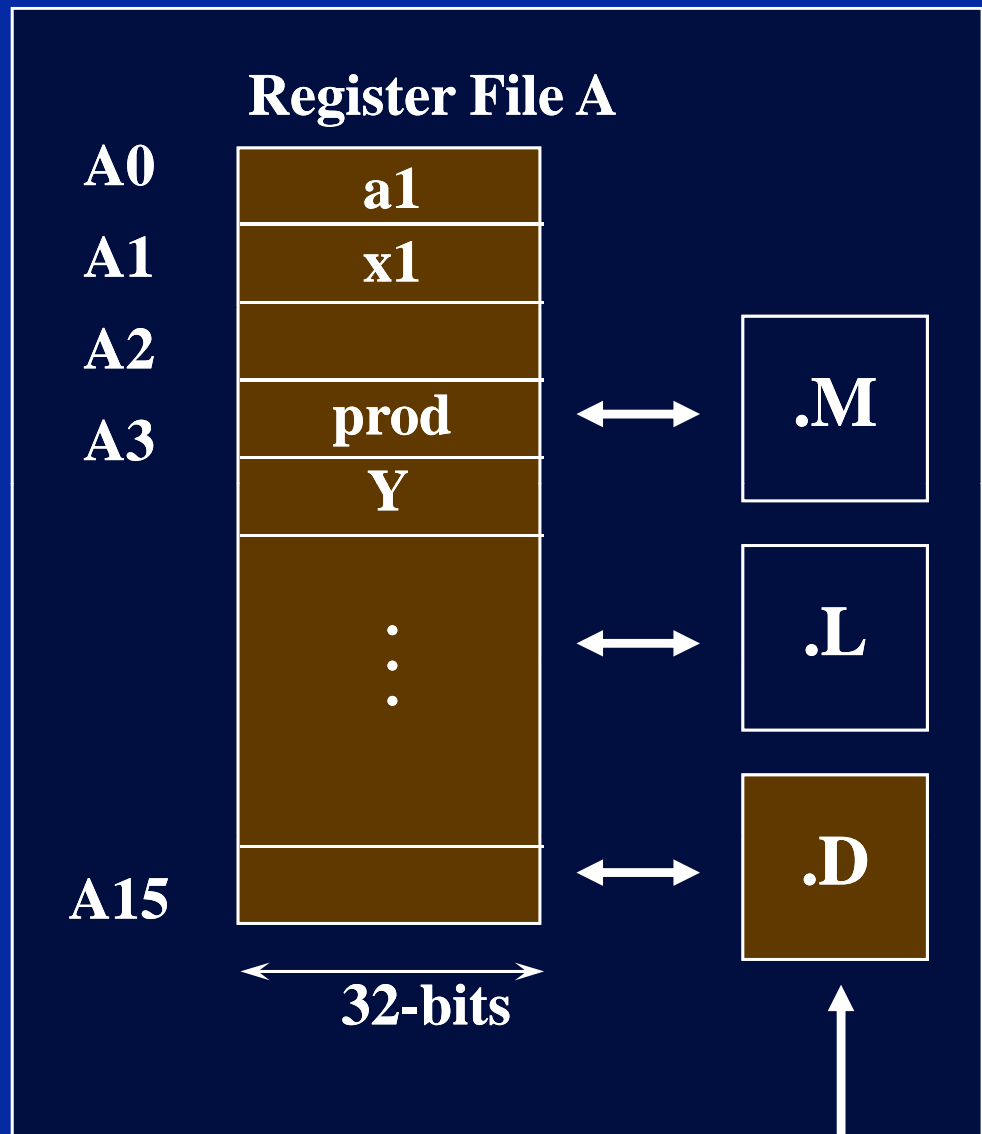

Q: How do we load the operands into the registers?

A: The operands are loaded into the registers by loading them from the memory using the .D unit.

Load Unit “.D”

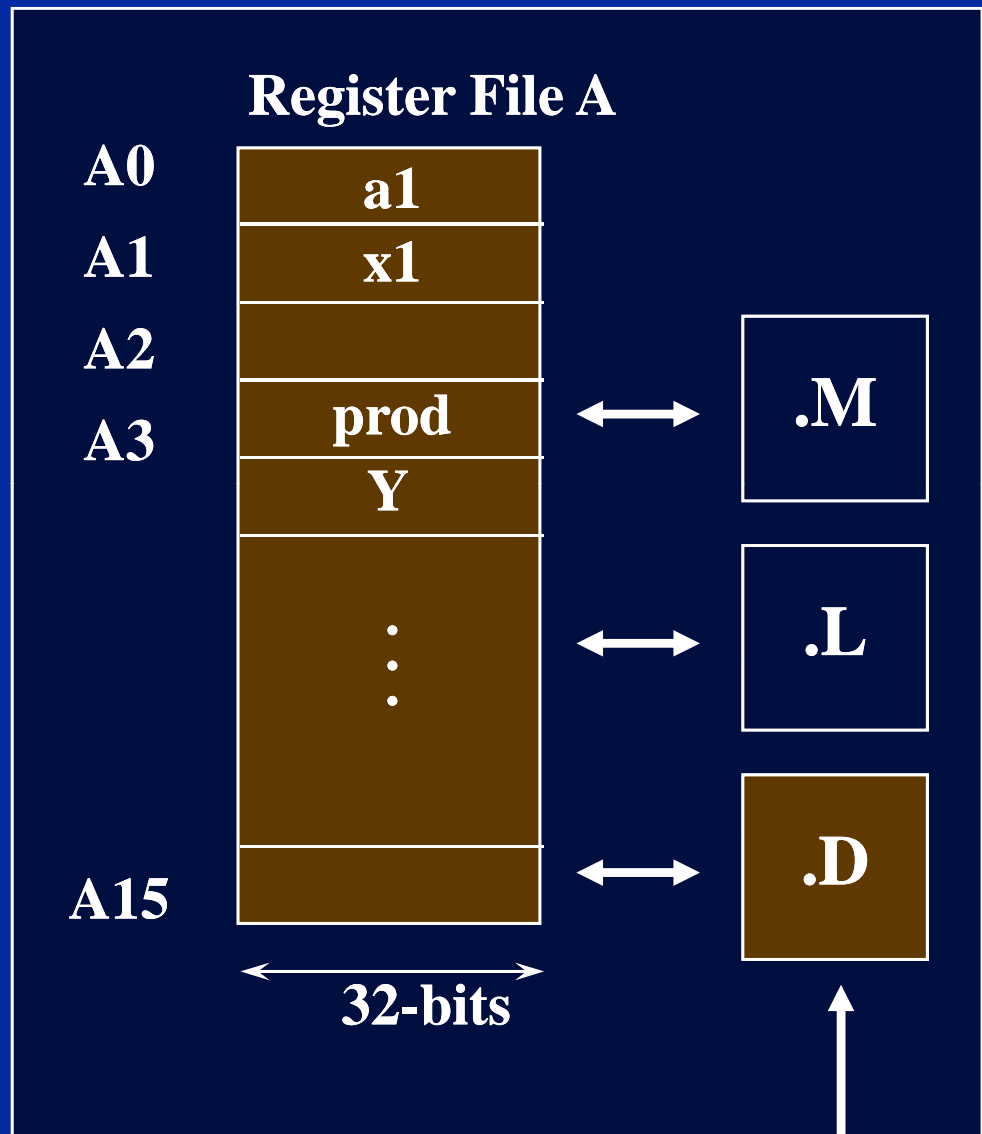

It is worth noting at this stage that the only way to access memory is through the .D unit.

Load Instructions (LDB, LDH,LDW,LDDW)

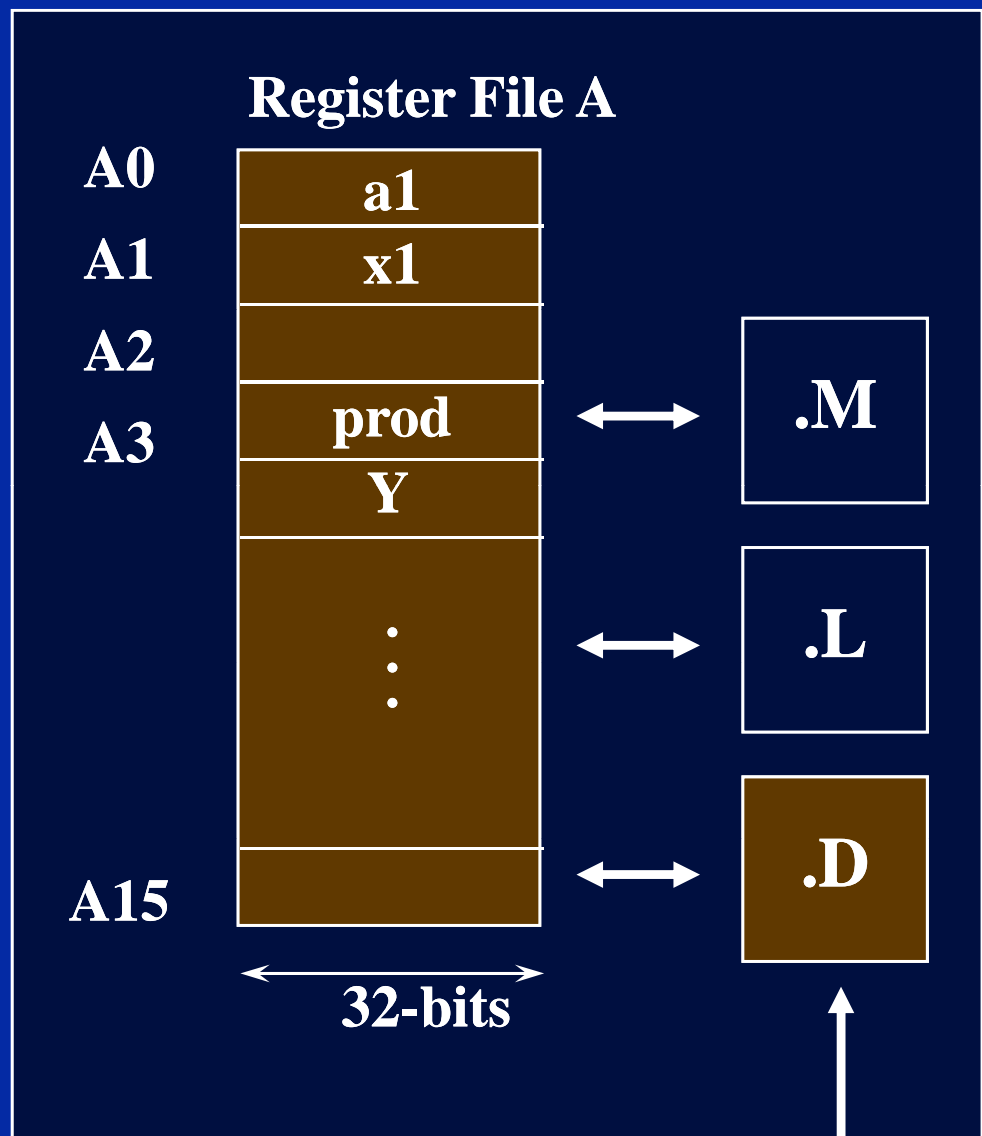

Q: Which instruction(s) can be used for loading operands from the memory to the registers?

A: The load instructions.

Using the Load Instructions

The syntax for the load instruction is:

```
LD *Rn,Rm
```

Where:

Rn is a register that contains the address of the operand to be loaded

and

Rm is the destination register.

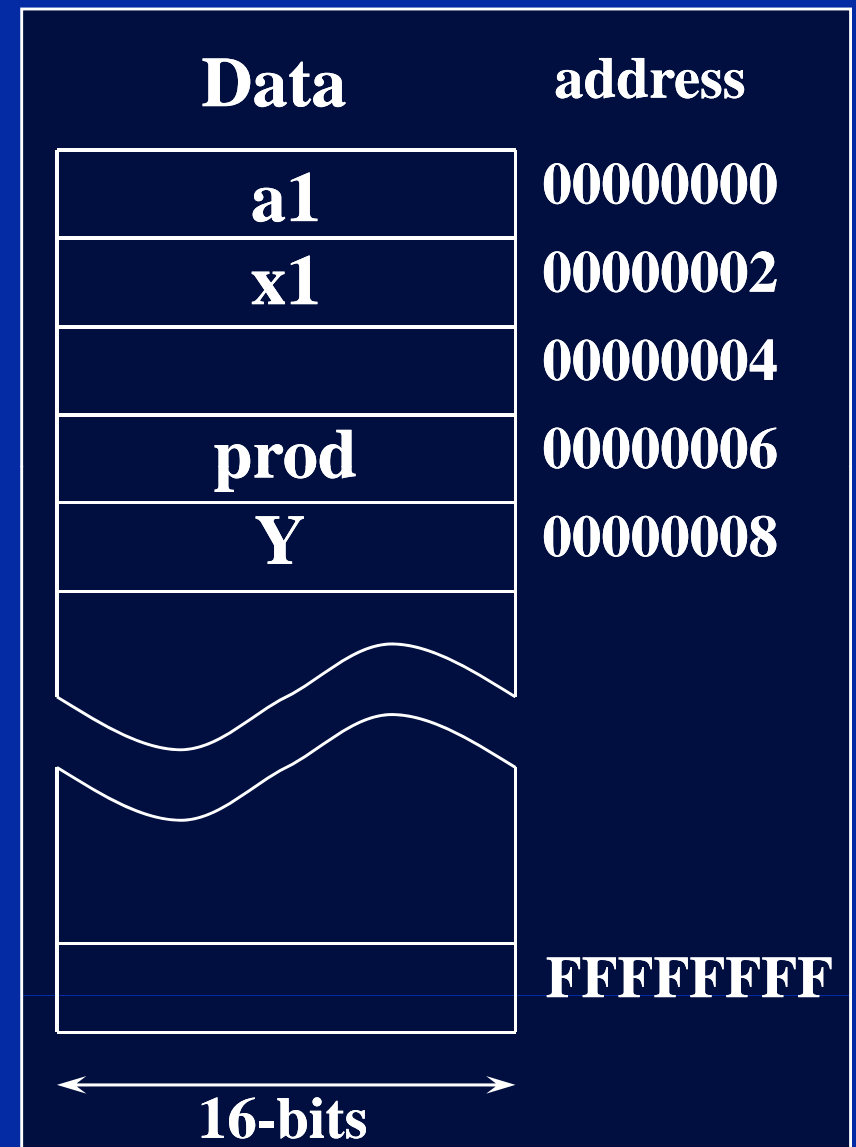

Using the Load Instructions

The syntax for the load instruction is:

LD *Rn,Rm

The question now is how many bytes are going to be loaded into the destination register?

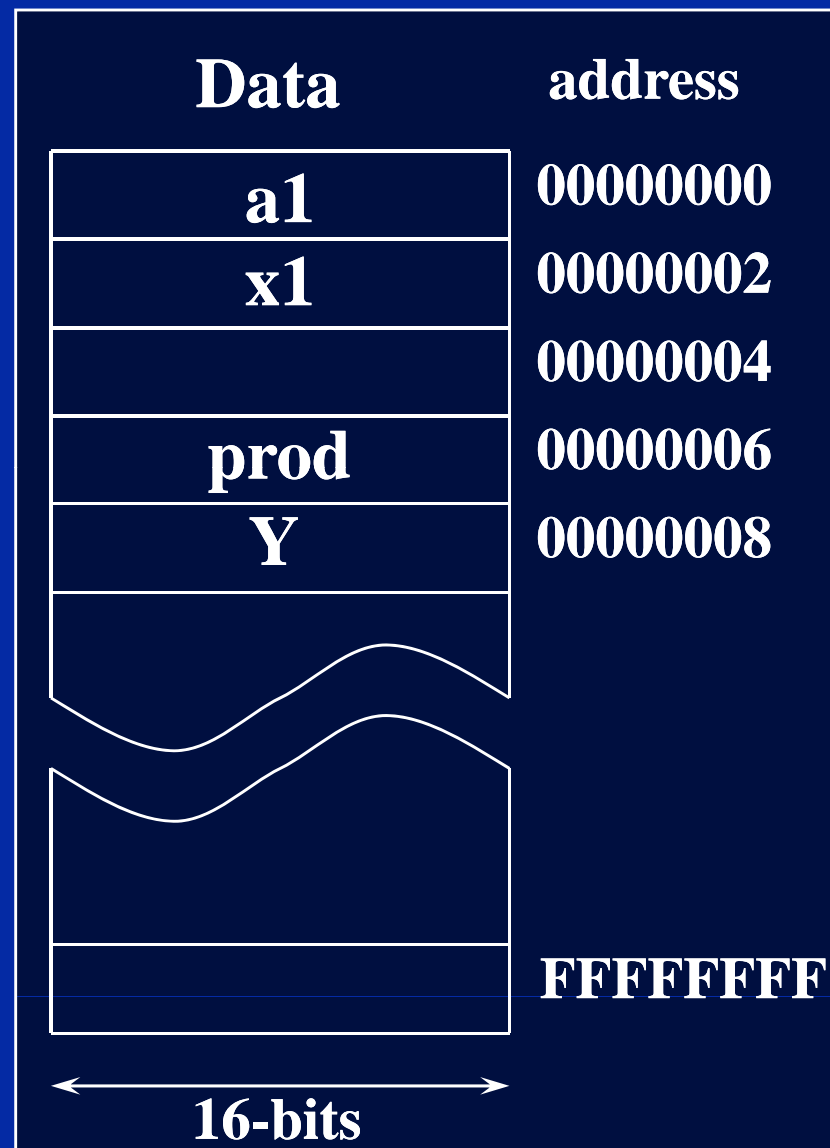

Using the Load Instructions

The syntax for the load instruction is:

LD *Rn,Rm

The answer, is that it depends on the instruction you choose:

- **LDB: loads one byte (8-bit)**
- **LDH: loads half word (16-bit)**
- **LDW: loads a word (32-bit)**
- **LDDW: loads a double word (64-bit)**

Note: LD on its own does not exist.

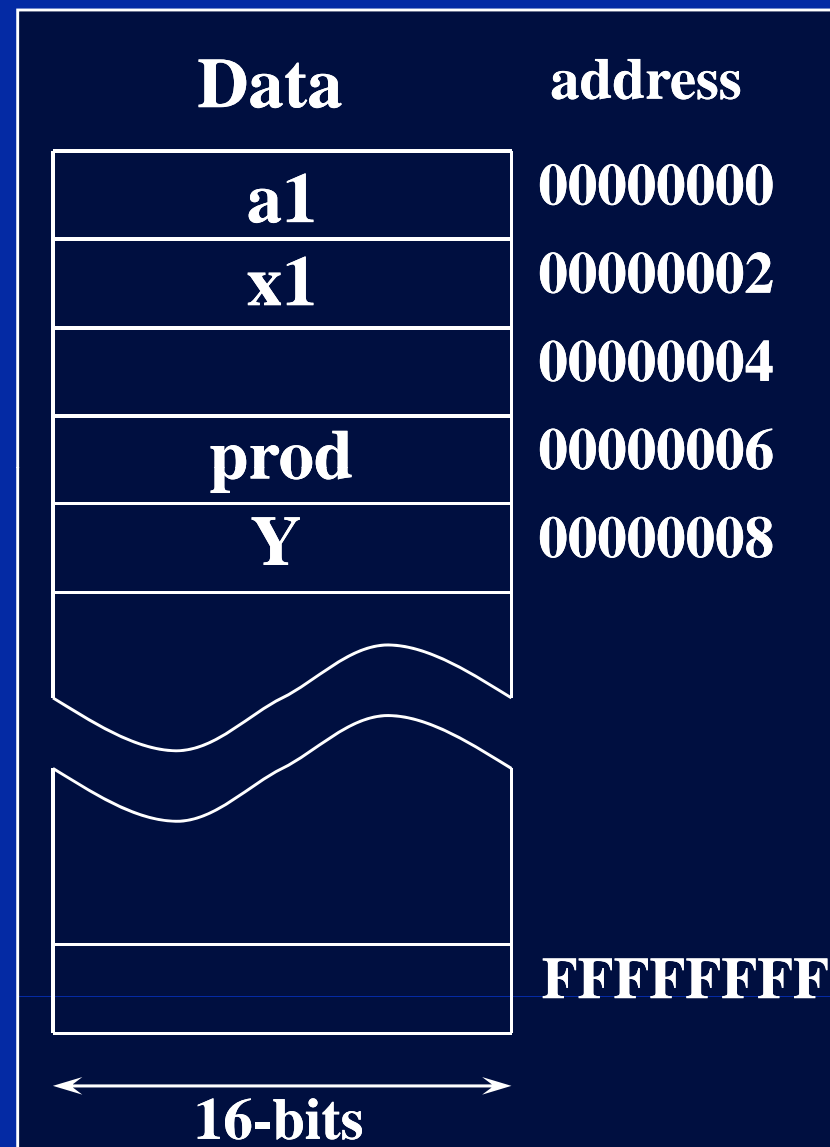

Using the Load Instructions

The syntax for the load instruction is:

LD *Rn,Rm

Example:

If we assume that A5 = 0x4 then:

- (1) **LDB *A5, A7 ; gives A7 = 0x00000001**
- (2) **LDH *A5,A7; gives A7 = 0x00000201**
- (3) **LDW *A5,A7; gives A7 = 0x04030201**
- (4) **LDDW *A5,A7:A6; gives A7:A6 = 0x0807060504030201**

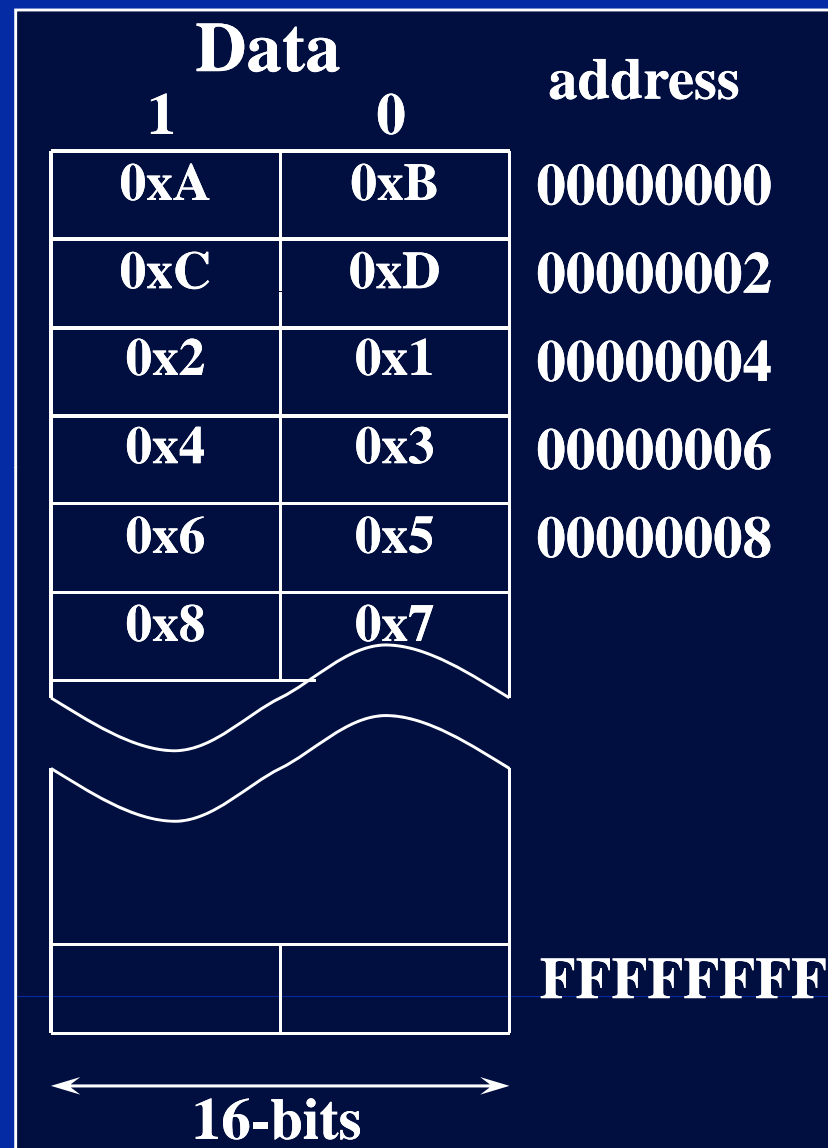

Loading the Pointer Rn

- ◆ The instruction **MVKL** will allow a move of a 16-bit constant into a register as shown below:

MVKL .? a, A5

(‘a’ is a constant or label)

- ◆ How many bits represent a full address?

32 bits

- ◆ So why does the instruction not allow a 32-bit move?

All instructions are 32-bit wide (see instruction opcode).

Loading the Pointer Rn

- ◆ To solve this problem another instruction is available:

MVKH

eg. **MVKH** **.?** **a, A5**
(‘a’ is a constant or label)

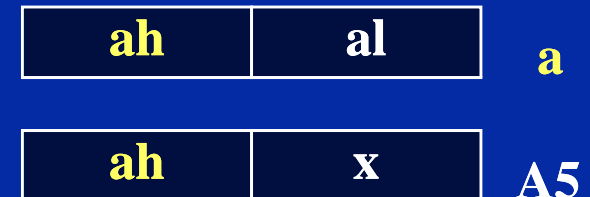

- ◆ Finally, to move the 32-bit address to a register we can use:

```
MVKL    a, A5
MVKH    a, A5
```

Loading the Pointer Rn

- ◆ Always use MVKL then MVKH, look at the following examples:

Example 1

A5 = 0x87654321

MVKL 0x1234FABC, A5
A5 = 0xFFFFFABC (sign extension)

MVKH 0x1234FABC, A5
A5 = 0x1234FABC ; OK

Example 2

MVKH 0x1234FABC, A5
A5 = 0x12344321

MVKL 0x1234FABC, A5
A5 = 0xFFFFFABC ; Wrong

LDH, MVKL and MVKH

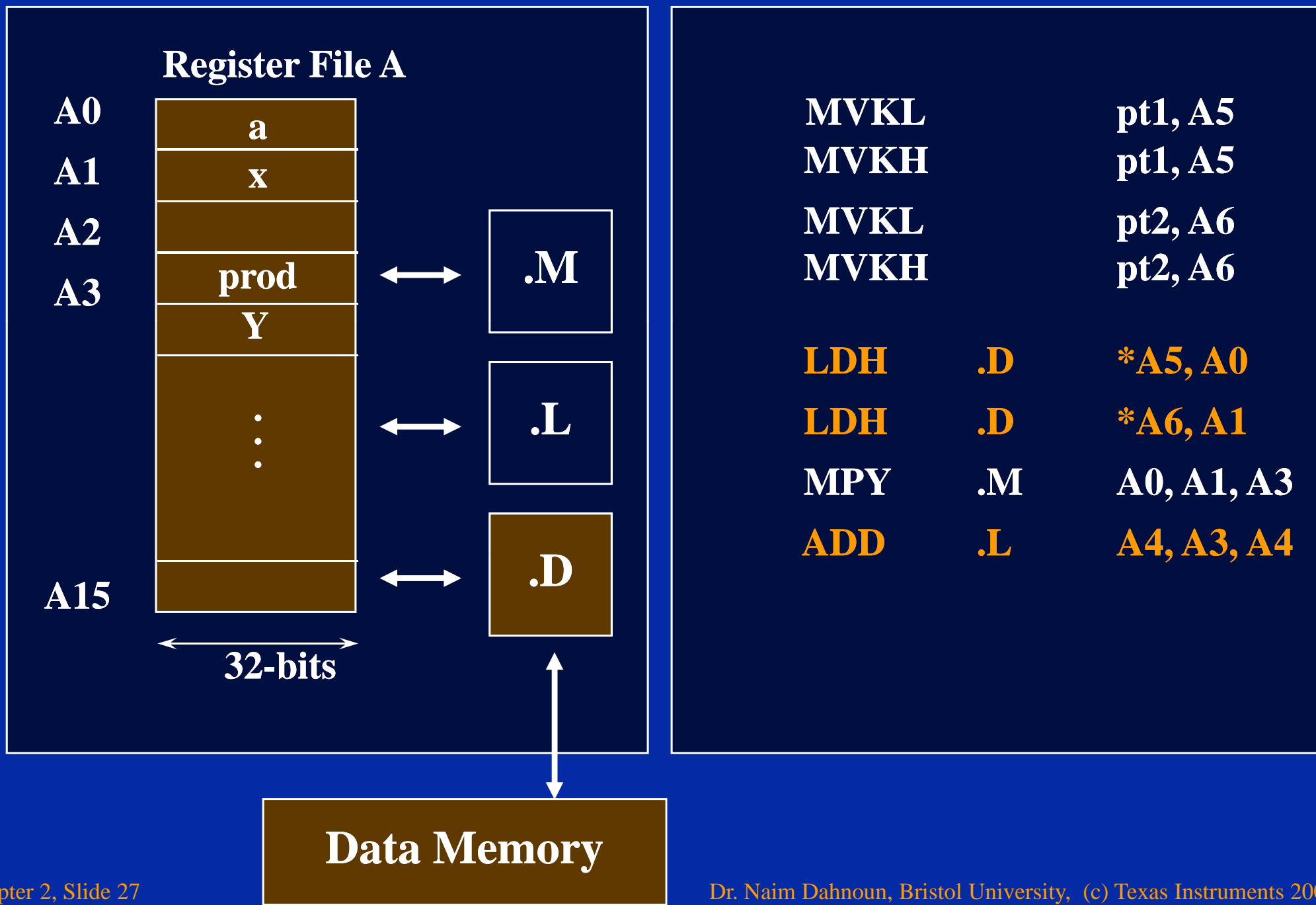

Creating a loop

So far we have only implemented the SOP for one tap only, i.e.

$$Y = a_1 * x_1$$

So let's create a loop so that we can implement the SOP for N Taps.

MVKL		pt1, A5
MVKH		pt1, A5
MVKL		pt2, A6
MVKH		pt2, A6
LDH	.D	*A5, A0
LDH	.D	*A6, A1
MPY	.M	A0, A1, A3
ADD	.L	A4, A3, A4

Creating a loop

So far we have only implemented the SOP for one tap only, i.e.

$$Y = a_1 * x_1$$

So let's create a loop so that we can implement the SOP for N Taps.

With the C6000 processors there are no dedicated instructions such as block repeat. The loop is created using the B instruction.

What are the steps for creating a loop

- 1. Create a label to branch to.**
- 2. Add a branch instruction, B.**
- 3. Create a loop counter.**
- 4. Add an instruction to decrement the loop counter.**
- 5. Make the branch conditional based on the value in the loop counter.**

1. Create a label to branch to

MVKL **pt1, A5**

MVKH **pt1, A5**

MVKL **pt2, A6**

MVKH **pt2, A6**

loop **LDH** **.D** ***A5, A0**

LDH **.D** ***A6, A1**

MPY **.M** **A0, A1, A3**

ADD **.L** **A4, A3, A4**

2. Add a branch instruction, B.

MVKL pt1, A5

MVKH pt1, A5

MVKL pt2, A6

MVKH pt2, A6

```
loop LDH .D *A5, A0
LDH .D *A6, A1
MPY .M A0, A1, A3
ADD .L A4, A3, A4
B .? loop
```

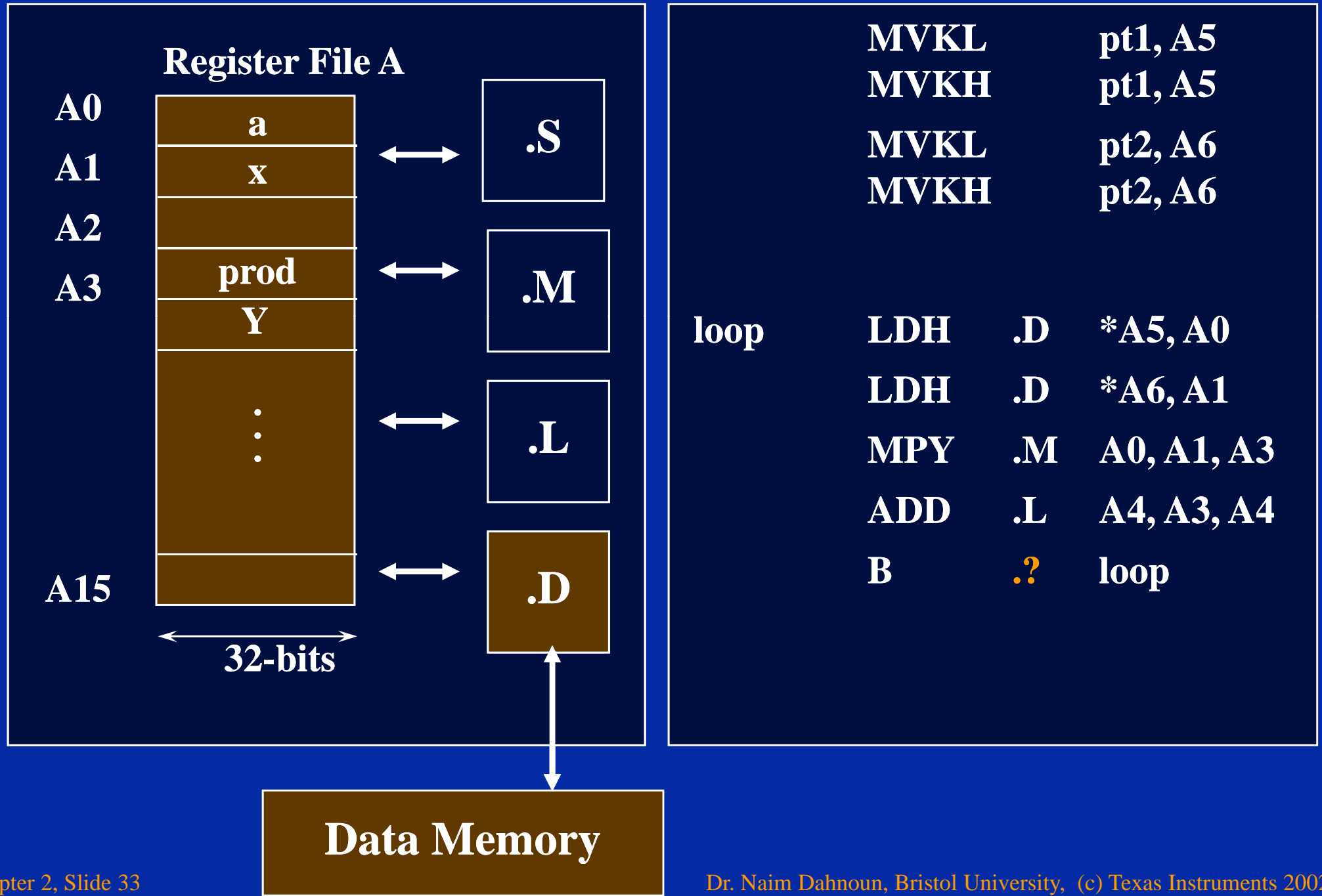

Which unit is used by the B instruction?

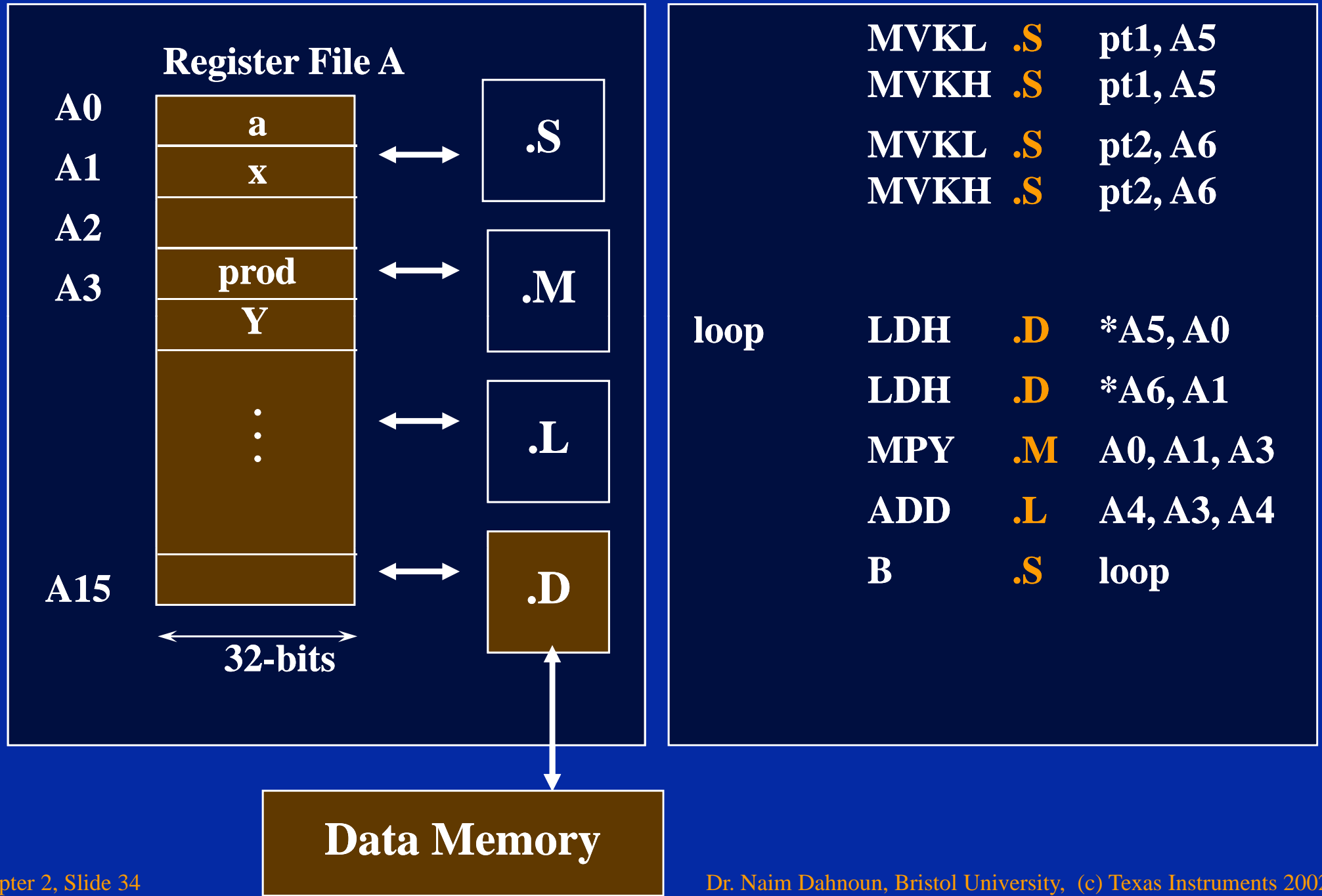

Which unit is used by the B instruction?

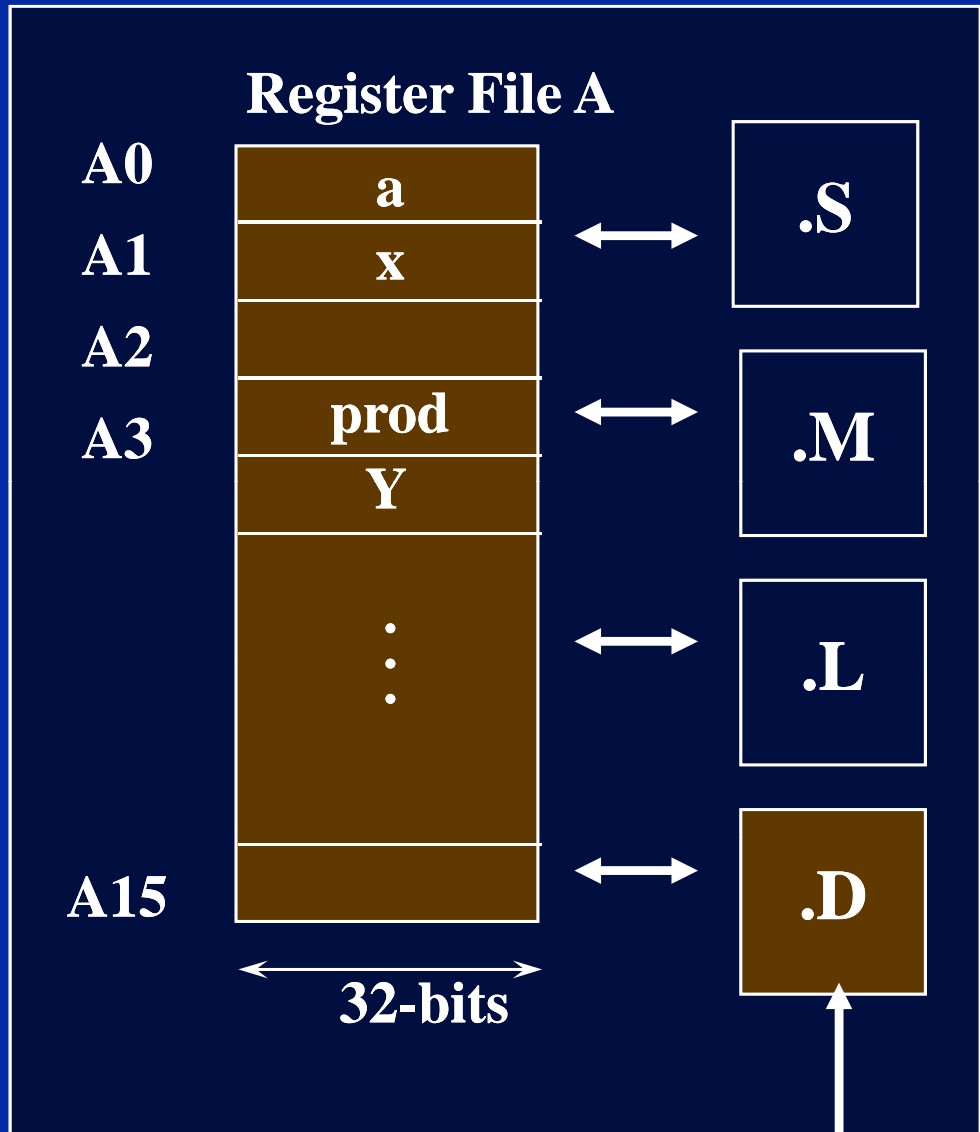

3. Create a loop counter.



```
MVKL .S pt1, A5
MVKH .S pt1, A5
MVKL .S pt2, A6
MVKH .S pt2, A6
MVKL .S count, B0
loop LDH .D *A5, A0
      LDH .D *A6, A1
      MPY .M A0, A1, A3
      ADD .L A4, A3, A4
      B .S loop
```

B registers will be introduced later

Data Memory

4. Decrement the loop counter

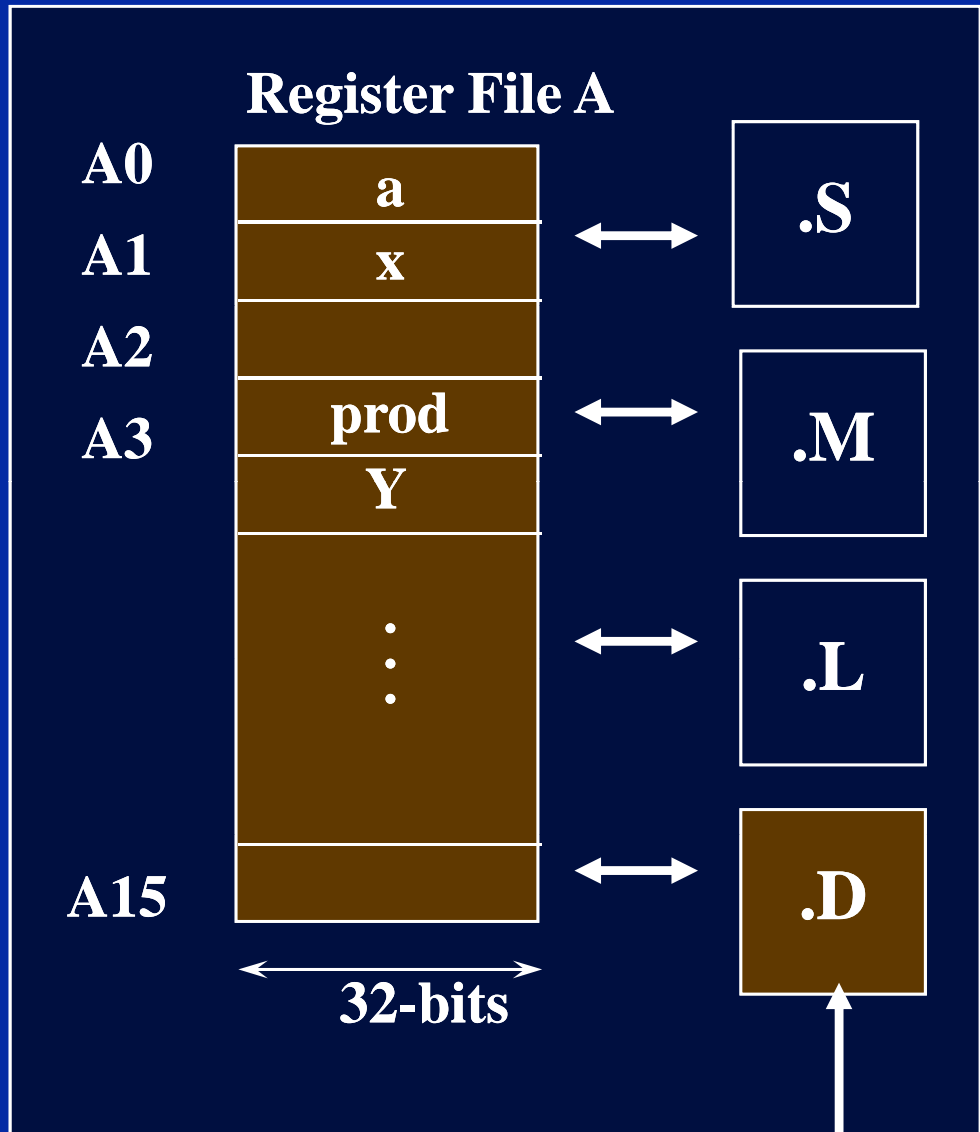

```

MVKL .S pt1, A5
MVKH .S pt1, A5
MVKL .S pt2, A6
MVKH .S pt2, A6
MVKL .S count, B0

loop LDH .D *A5, A0
      LDH .D *A6, A1
      MPY .M A0, A1, A3
      ADD .L A4, A3, A4
      SUB .S B0, 1, B0
      B .S loop
    
```



5. Make the branch conditional based on the value in the loop counter

- ◆ What is the syntax for making instruction conditional?

[**condition**] Instruction Label

e.g.

[B1] B loop

- (1) The **condition** can be one of the following registers: A1, A2, B0, B1, B2.
- (2) Any instruction can be conditional.

5. Make the branch conditional based on the value in the loop counter

- ◆ The condition can be inverted by adding the exclamation symbol “!” as follows:

[!condition]	Instruction	Label
---------------------	--------------------	--------------

e.g.

[!B0]	B	loop ;branch if B0 = 0
--------------	----------	-------------------------------

[B0]	B	loop ;branch if B0 != 0
-------------	----------	--------------------------------

5. Make the branch conditional

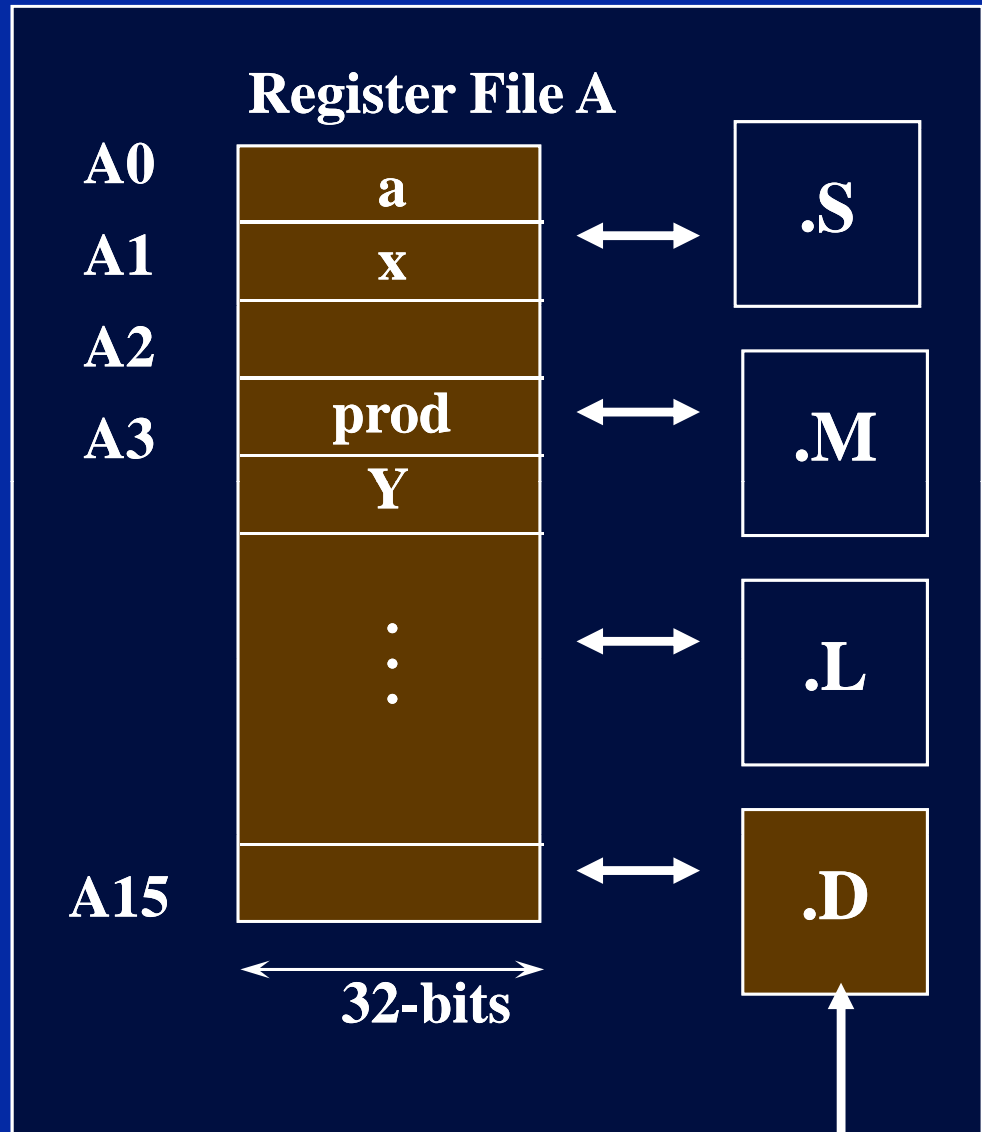

```
MVKL .S2 pt1, A5
MVKH .S2 pt1, A5
MVKL .S2 pt2, A6
MVKH .S2 pt2, A6
MVKL .S2 count, B0

loop LDH .D *A5, A0
      LDH .D *A6, A1
      MPY .M A0, A1, A3
      ADD .L A4, A3, A4
      SUB .S B0, 1, B0

[B0] B .S loop
```



More on the Branch Instruction (1)

- ◆ With this processor all the instructions are encoded in a 32-bit.
- ◆ Therefore the label must have a dynamic range of less than 32-bit as the instruction B has to be coded.



- ◆ Case 1: B .S1 *label*
 - ◆ Relative branch.
 - ◆ Label limited to +/- 2^{20} offset.

More on the Branch Instruction (2)

- ◆ By specifying a register as an operand instead of a label, it is possible to have an absolute branch.
- ◆ This will allow a dynamic range of 2^{32} .



- ◆ Case 2: **B** **.S2** *register*
 - ◆ Absolute branch.
 - ◆ Operates on **.S2 ONLY!**

Testing the code

This code performs the following operations:

$$a_0 * x_0 + a_0 * x_0 + a_0 * x_0 + \dots + a_0 * x_0$$

However, we would like to perform:

$$a_0 * x_0 + a_1 * x_1 + a_2 * x_2 + \dots + a_N * x_N$$

```
MVKL .S2 pt1, A5
MVKH .S2 pt1, A5

MVKL .S2 pt2, A6
MVKH .S2 pt2, A6
MVKL .S2 count, B0

loop LDH .D *A5, A0
      LDH .D *A6, A1
      MPY .M A0, A1, A3
      ADD .L A4, A3, A4
      SUB .S B0, 1, B0

[B0] B .S loop
```

Modifying the pointers

The solution is to modify the pointers

A5 and A6.

```
MVKL .S2 pt1, A5
MVKH .S2 pt1, A5
MVKL .S2 pt2, A6
MVKH .S2 pt2, A6
MVKL .S2 count, B0

loop LDH .D *A5, A0
     LDH .D *A6, A1
     MPY .M A0, A1, A3
     ADD .L A4, A3, A4
     SUB .S B0, 1, B0

[B0] B .S loop
```

Indexing Pointers

Syntax	Description	Pointer Modified
*R	Pointer	No

In this case the pointers are used but not modified.

R can be any register

Indexing Pointers

Syntax	Description	Pointer Modified
*R	Pointer	No
*+R [disp]	+ Pre-offset	No
*-R [disp]	- Pre-offset	No

In this case the pointers are modified **BEFORE** being used and **RESTORED** to their previous values.

- ◆ [disp] specifies the number of elements size in DW (64-bit), W (32-bit), H (16-bit), or B (8-bit).
- ◆ disp = R or 5-bit constant.
- ◆ R can be any register.

Indexing Pointers

Syntax	Description	Pointer Modified
*R	Pointer	No
*+R [disp]	+ Pre-offset	No
*-R [disp]	- Pre-offset	No
*++R [disp]	Pre-increment	Yes
*--R [disp]	Pre-decrement	Yes

In this case the pointers are modified **BEFORE** being used and **NOT RESTORED** to their Previous Values.

Indexing Pointers

Syntax	Description	Pointer Modified
*R	Pointer	No
*+R [disp]	+ Pre-offset	No
*-R [disp]	- Pre-offset	No
*++R [disp]	Pre-increment	Yes
*--R [disp]	Pre-decrement	Yes
*R++ [disp]	Post-increment	Yes
*R-- [disp]	Post-decrement	Yes

In this case the pointers are modified **AFTER** being used and **NOT RESTORED** to their Previous Values.

Indexing Pointers

Syntax	Description	Pointer Modified
*R	Pointer	No
*+R [disp]	+ Pre-offset	No
*-R [disp]	- Pre-offset	No
*++R [disp]	Pre-increment	Yes
*--R [disp]	Pre-decrement	Yes
*R++ [disp]	Post-increment	Yes
*R-- [disp]	Post-decrement	Yes

- ◆ [disp] specifies # elements - size in DW, W, H, or B.
- ◆ disp = **R** or 5-bit constant.
- ◆ **R** can be any register.

Modify and testing the code

This code now performs the following operations:

$$a_0 * x_0 + a_1 * x_1 + a_2 * x_2 + \dots + a_N * x_N$$

```
MVKL .S2 pt1, A5
MVKH .S2 pt1, A5
MVKL .S2 pt2, A6
MVKH .S2 pt2, A6
MVKL .S2 count, B0

loop LDH .D *A5++, A0
     LDH .D *A6++, A1
     MPY .M A0, A1, A3
     ADD .L A4, A3, A4
     SUB .S B0, 1, B0

[B0] B .S loop
```

Store the final result

This code now performs the following operations:

$$a_0 * x_0 + a_1 * x_1 + a_2 * x_2 + \dots + a_N * x_N$$

```
MVKL .S2 pt1, A5
MVKH .S2 pt1, A5
MVKL .S2 pt2, A6
MVKH .S2 pt2, A6
MVKL .S2 count, B0

loop LDH .D *A5++, A0
     LDH .D *A6++, A1
     MPY .M A0, A1, A3
     ADD .L A4, A3, A4
     SUB .S B0, 1, B0

[B0] B .S loop
     STH .D A4, *A7
```

Store the final result

The Pointer A7 has not been initialised.

```
MVKL .S2 pt1, A5
MVKH .S2 pt1, A5
MVKL .S2 pt2, A6
MVKH .S2 pt2, A6
MVKL .S2 count, B0

loop LDH .D *A5++, A0
     LDH .D *A6++, A1
     MPY .M A0, A1, A3
     ADD .L A4, A3, A4
     SUB .S B0, 1, B0

[B0] B .S loop
     STH .D A4, *A7
```

Store the final result

The Pointer A7 is now initialised.

```
MVKL .S2 pt1, A5
MVKH .S2 pt1, A5
MVKL .S2 pt2, A6
MVKH .S2 pt2, A6
MVKL .S2 pt3, A7
MVKH .S2 pt3, A7
MVKL .S2 count, B0

loop LDH .D *A5++, A0
     LDH .D *A6++, A1
     MPY .M A0, A1, A3
     ADD .L A4, A3, A4
     SUB .S B0, 1, B0

[B0] B .S loop
     STH .D A4, *A7
```

What is the initial value of A4?

A4 is used as an accumulator,
so it needs to be reset to zero.

```
MVKL .S2 pt1, A5
MVKH .S2 pt1, A5

MVKL .S2 pt2, A6
MVKH .S2 pt2, A6

MVKL .S2 pt3, A7
MVKH .S2 pt3, A7
MVKL .S2 count, B0
ZERO .L A4
loop LDH .D *A5++, A0
      LDH .D *A6++, A1
      MPY .M A0, A1, A3
      ADD .L A4, A3, A4
      SUB .S B0, 1, B0
[B0] B .S loop
      STH .D A4, *A7
```

Increasing the processing power!

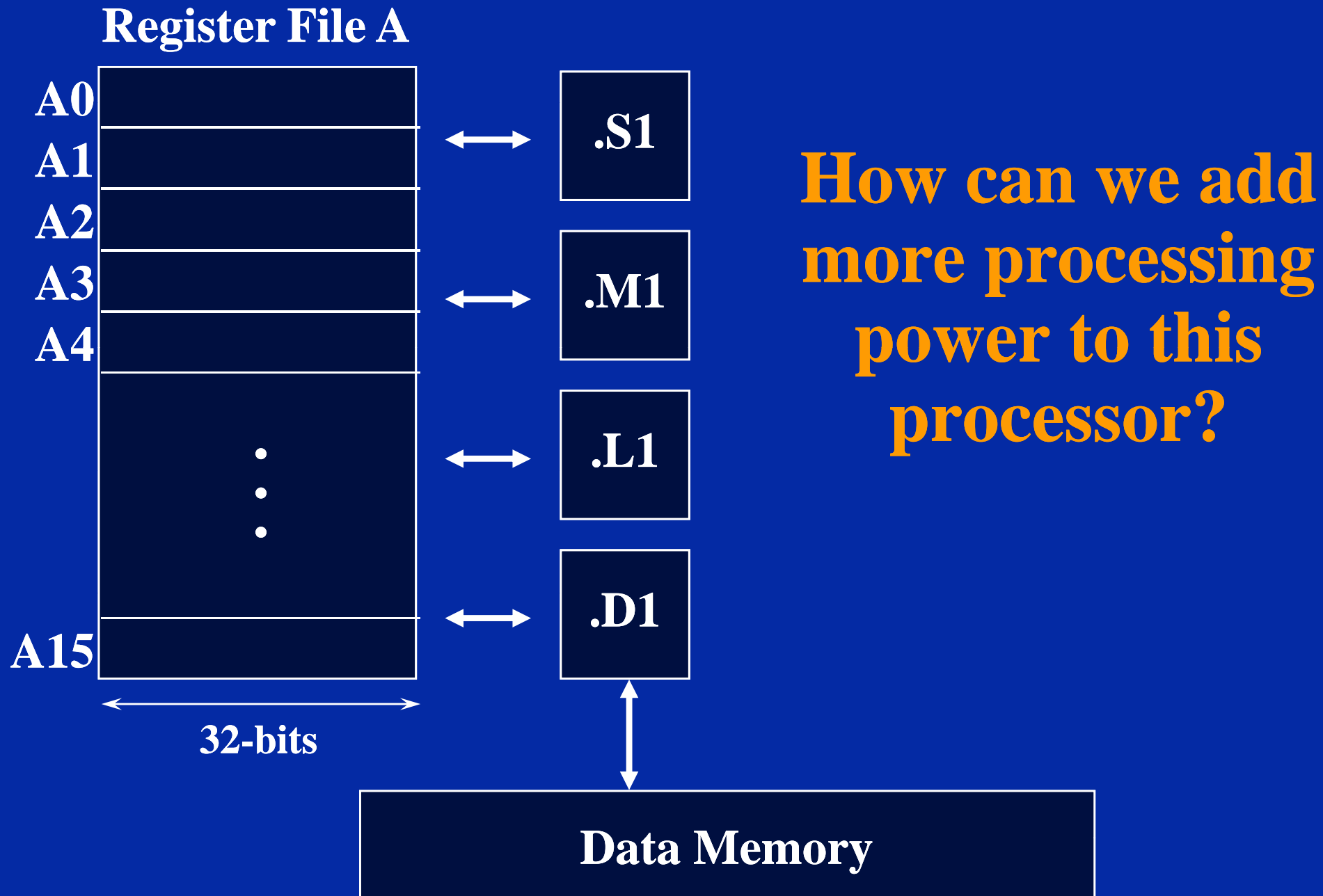

Increasing the processing power!

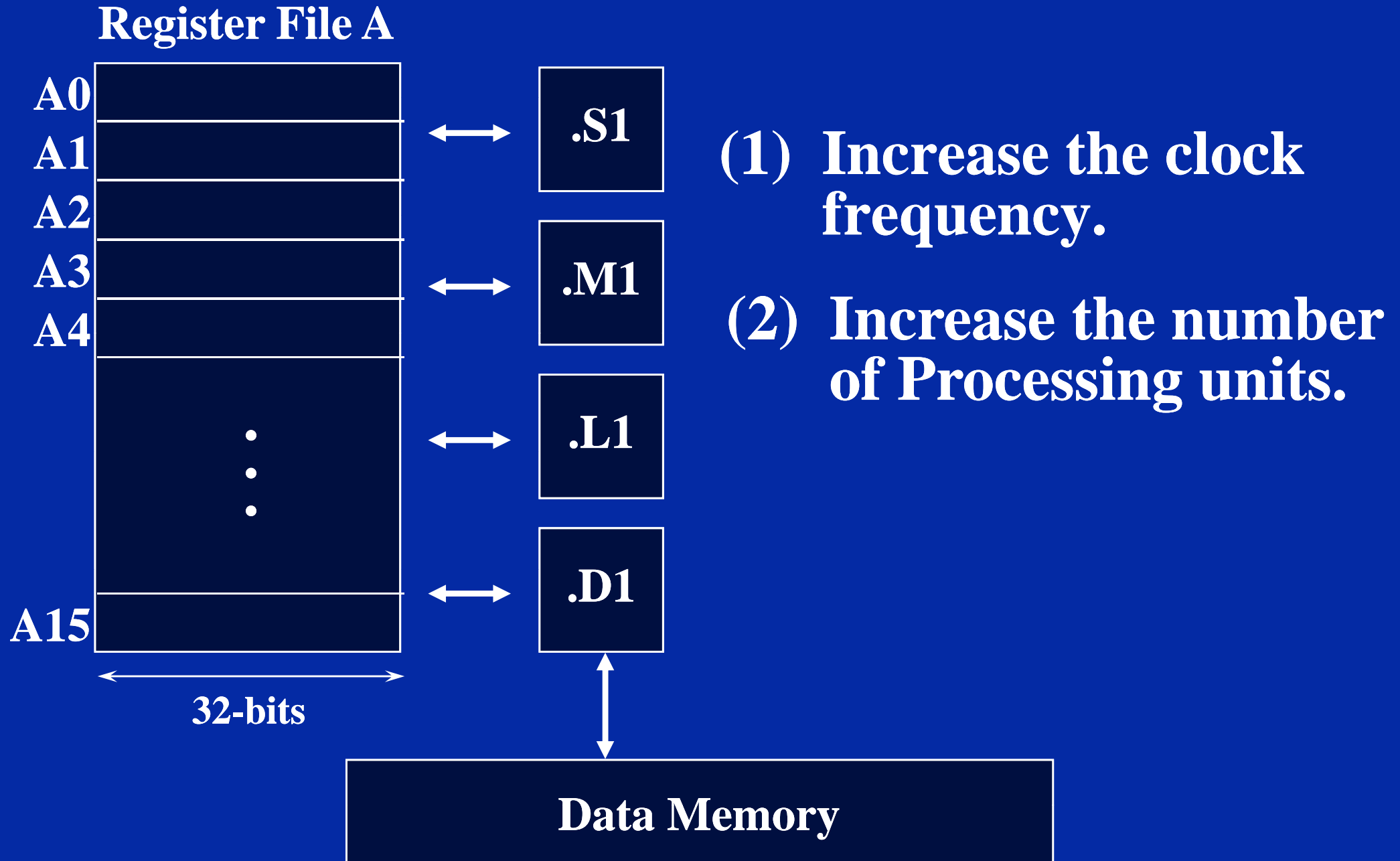

To increase the Processing Power, this processor has two sides (A and B or 1 and 2)

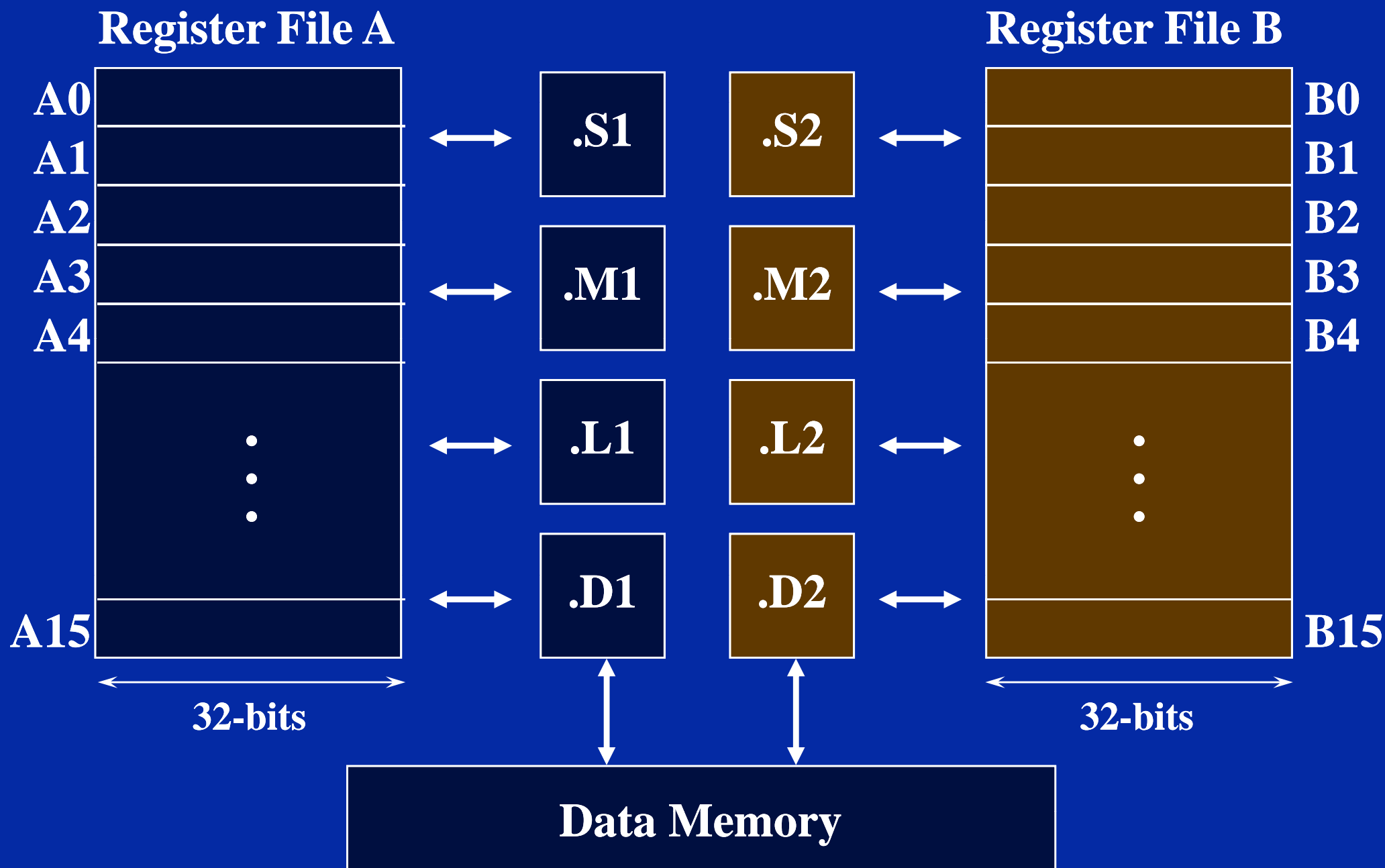

Can the two sides exchange operands in order to increase performance?

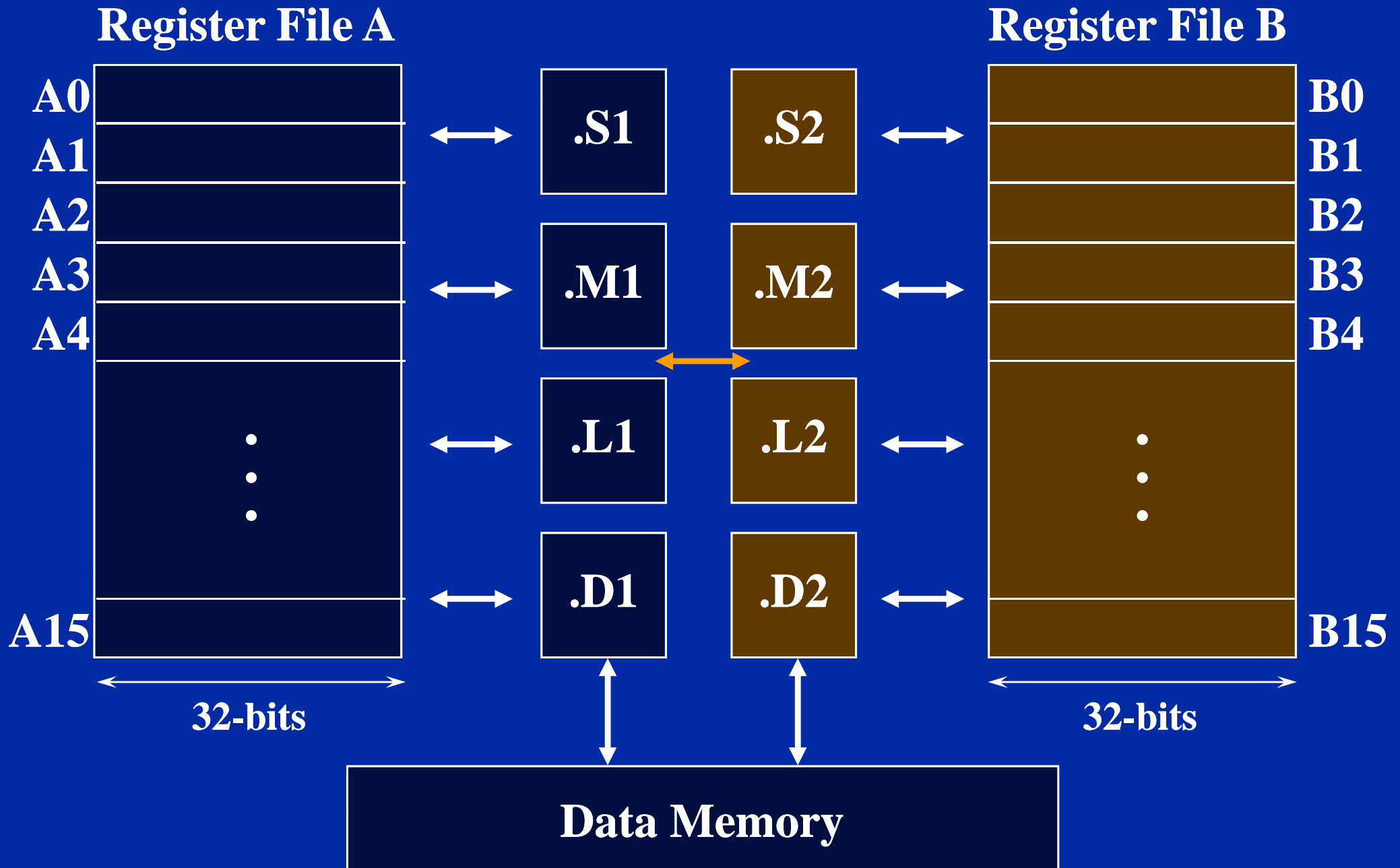

The answer is YES but there are limitations.

- ◆ To exchange operands between the two sides, some cross paths or links are required.

What is a cross path?

- ◆ A cross path links one side of the CPU to the other.
- ◆ There are two types of cross paths:
 - ◆ **Data** cross paths.
 - ◆ **Address** cross paths.

Data Cross Paths

- ◆ **Data cross paths can also be referred to as register file cross paths.**
- ◆ **These cross paths allow operands from one side to be used by the other side.**
- ◆ **There are only two cross paths:**
 - ◆ **one path which conveys data from side B to side A, 1X.**
 - ◆ **one path which conveys data from side A to side B, 2X.**

TMS320C67x Data-Path

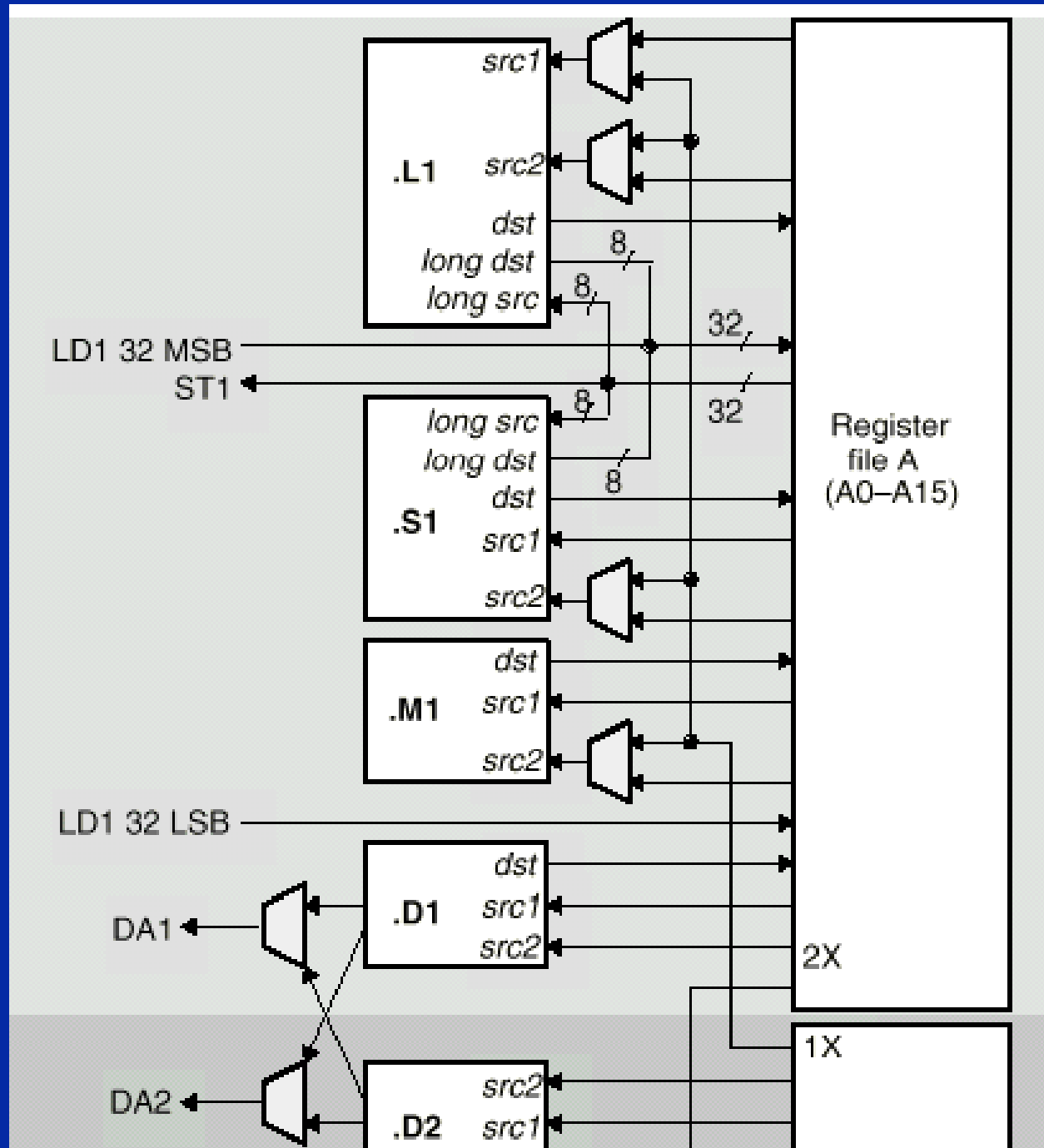

Data Cross Paths

- ◆ **Data cross paths only apply to the .L, .S and .M units.**
- ◆ **The data cross paths are very useful, however there are some limitations in their use.**

Data Cross Path Limitations

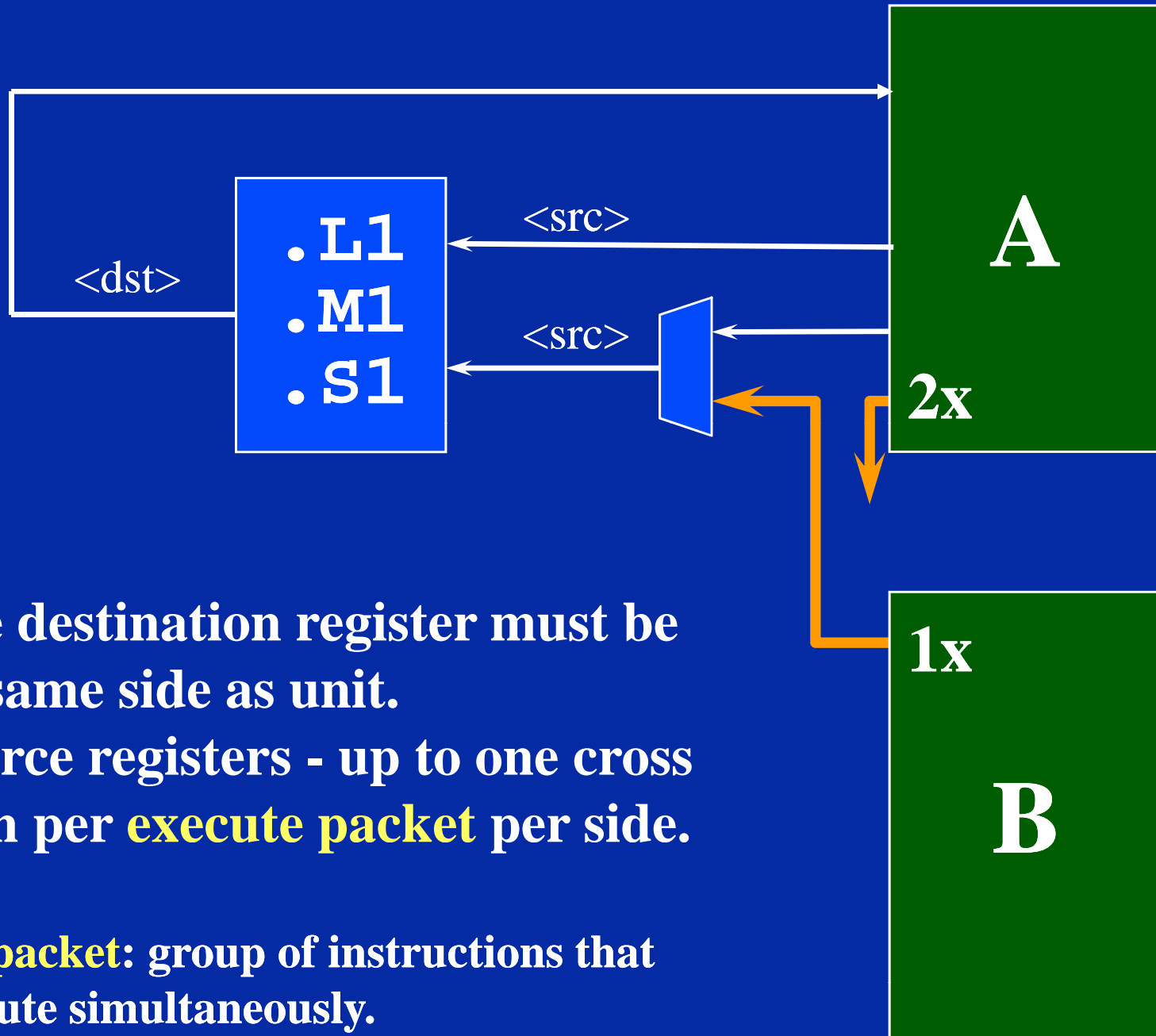

- (1) The destination register must be on same side as unit.
- (2) Source registers - up to one cross path per **execute packet** per side.

Execute packet: group of instructions that execute simultaneously.

Data Cross Path Limitations

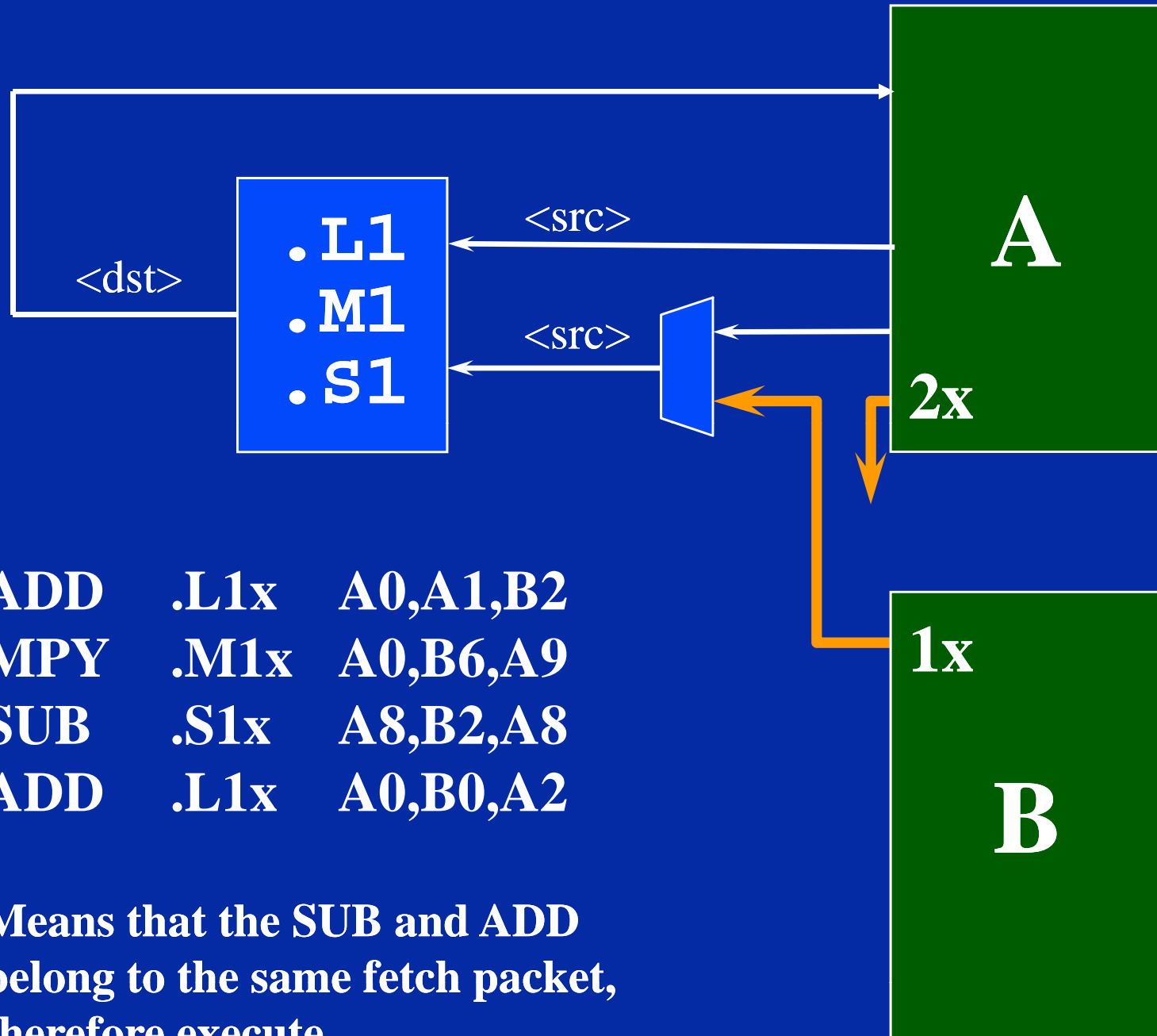

eg:

ADD .L1x A0,A1,B2

MPY .M1x A0,B6,A9

SUB .S1x A8,B2,A8

|| ADD .L1x A0,B0,A2

|| Means that the SUB and ADD belong to the same fetch packet, therefore execute simultaneously.

Data Cross Path Limitations

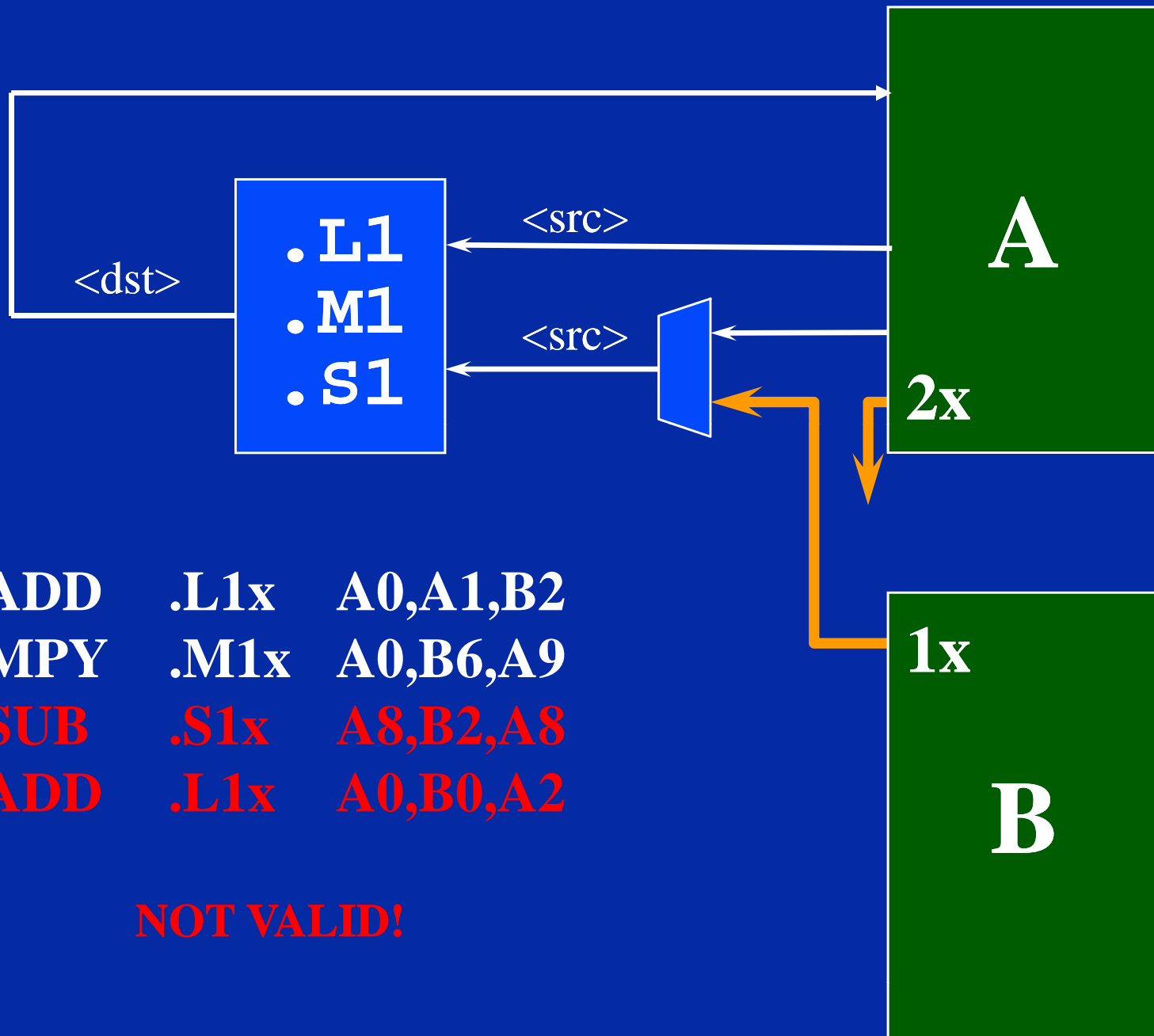

eg:

```
ADD  .L1x  A0,A1,B2
MPY  .M1x  A0,B6,A9
SUB  .S1x  A8,B2,A8
|| ADD  .L1x  A0,B0,A2
```

NOT VALID!

Data Cross Paths for both sides

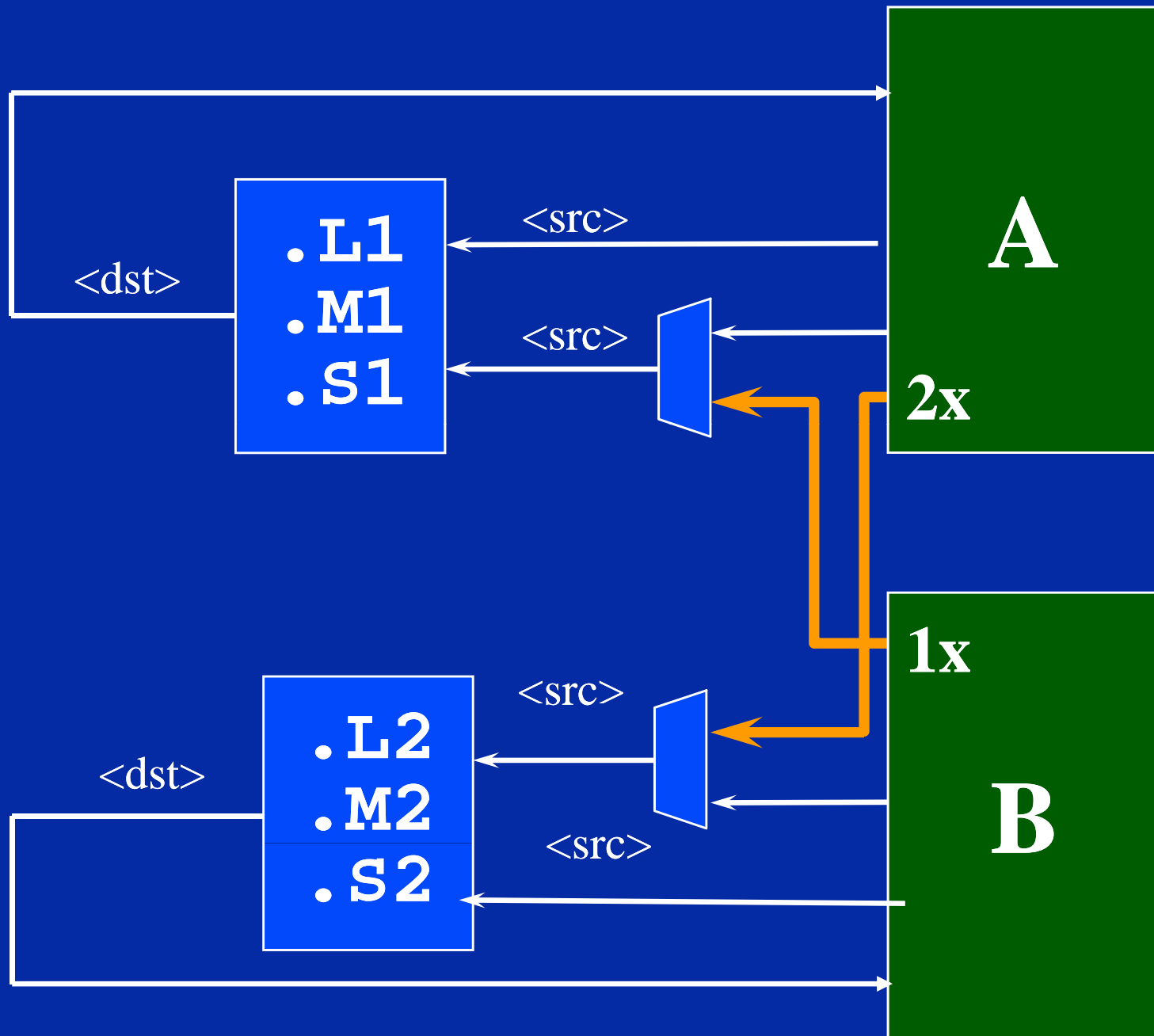

Address cross paths

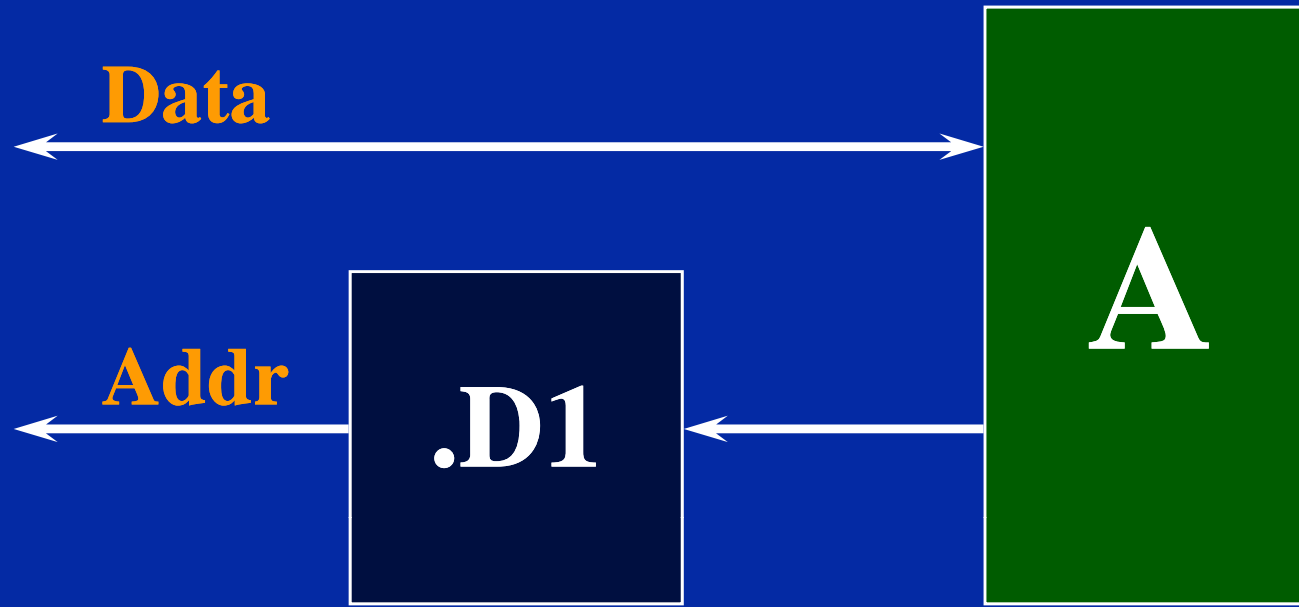

- (1) The pointer must be on the same side of the unit.

```
LDW.D1T1 *A0, A5  
STW.D1T1 A5, *A0
```

Load or store to either side

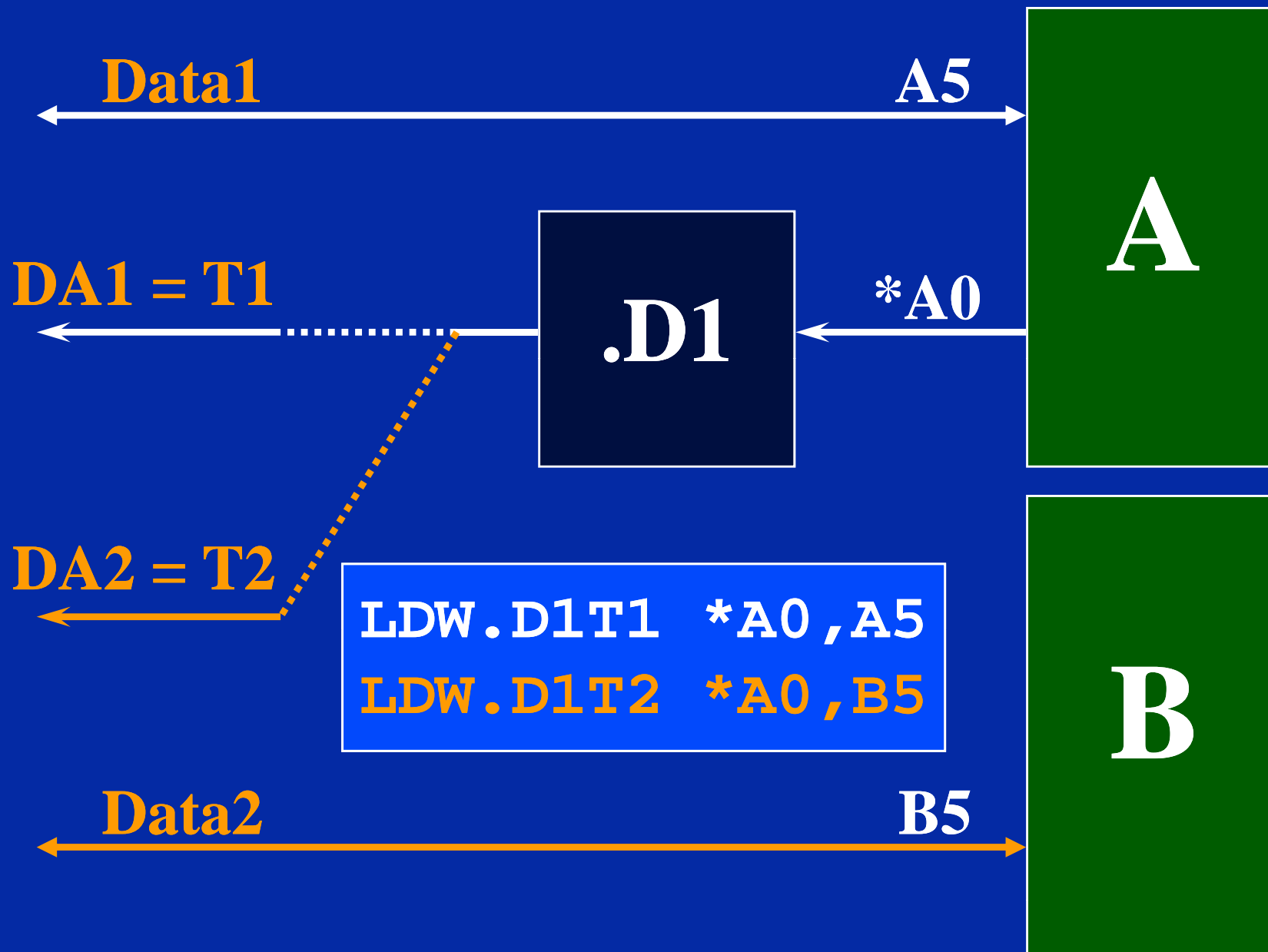

Standard Parallel Loads

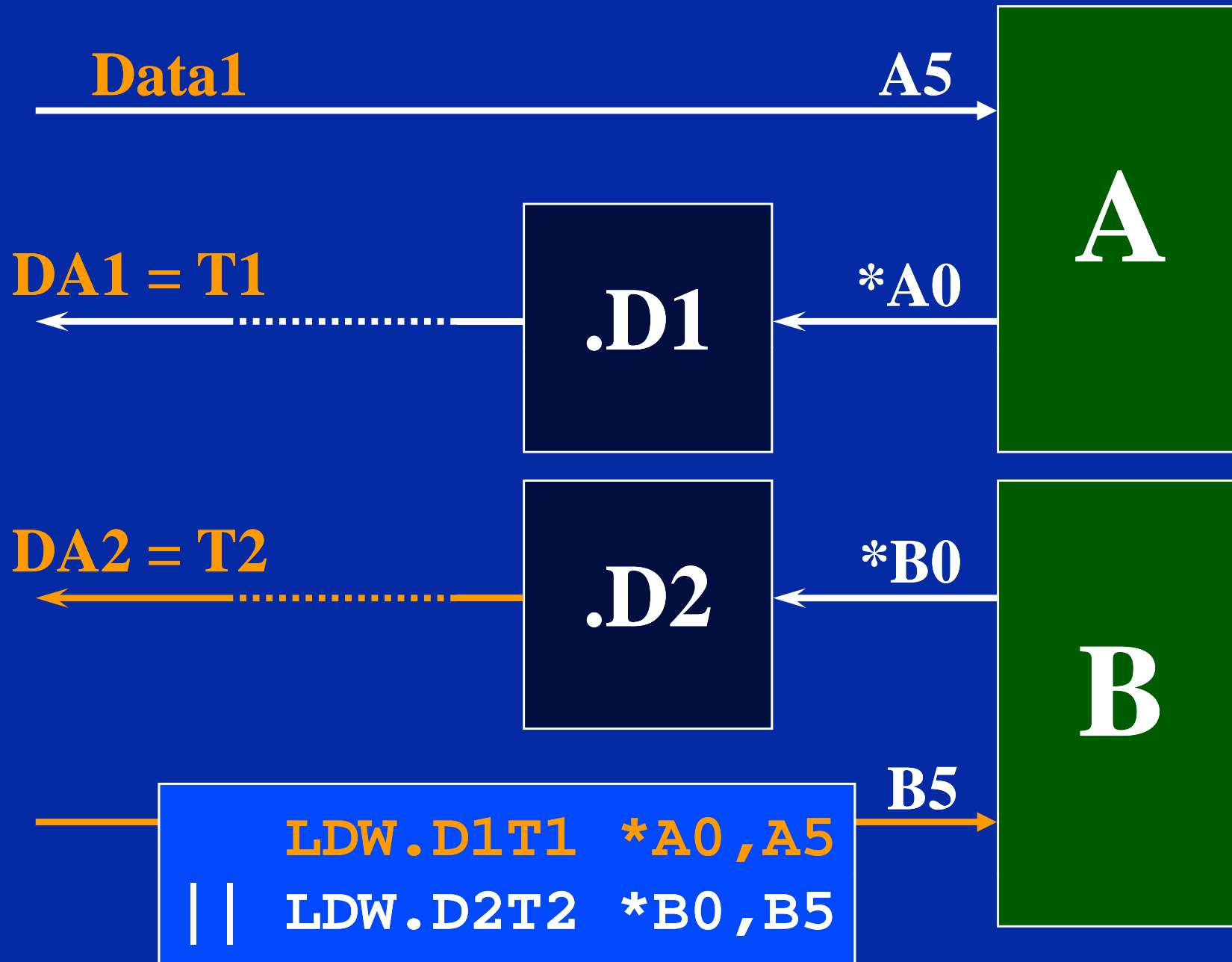

Parallel Load/Store using address cross paths

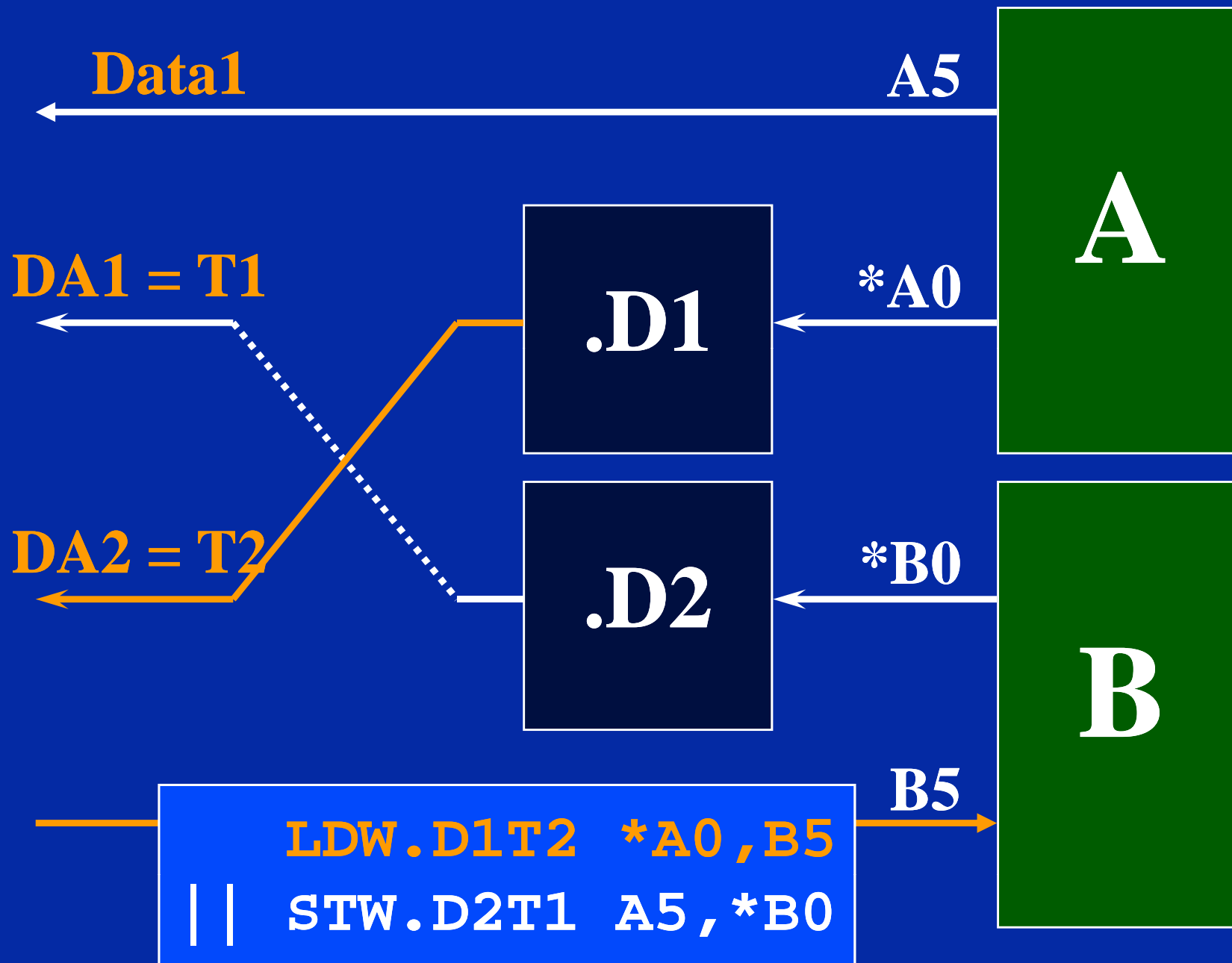

Fill the blanks ... Does this work?

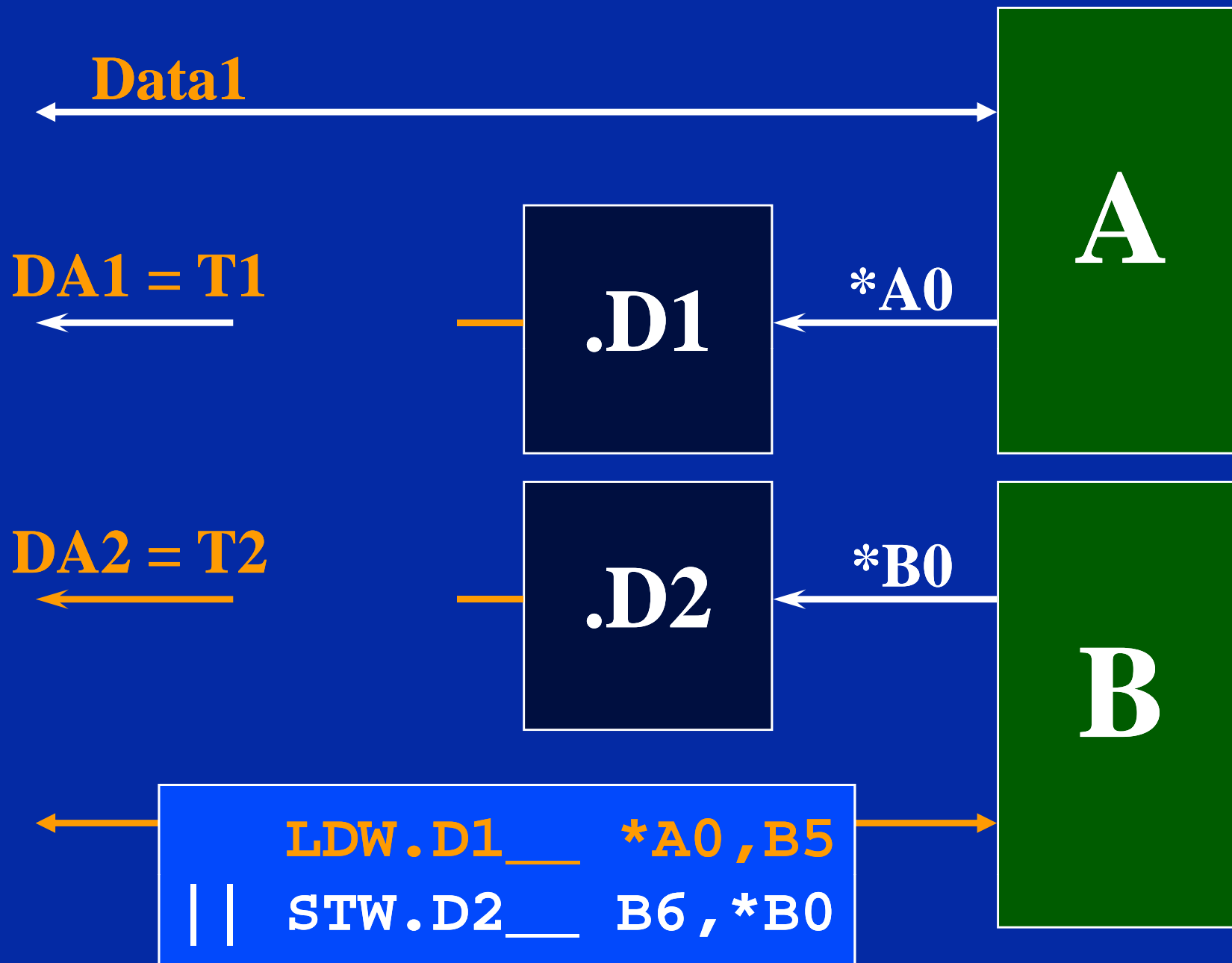

Not Allowed!

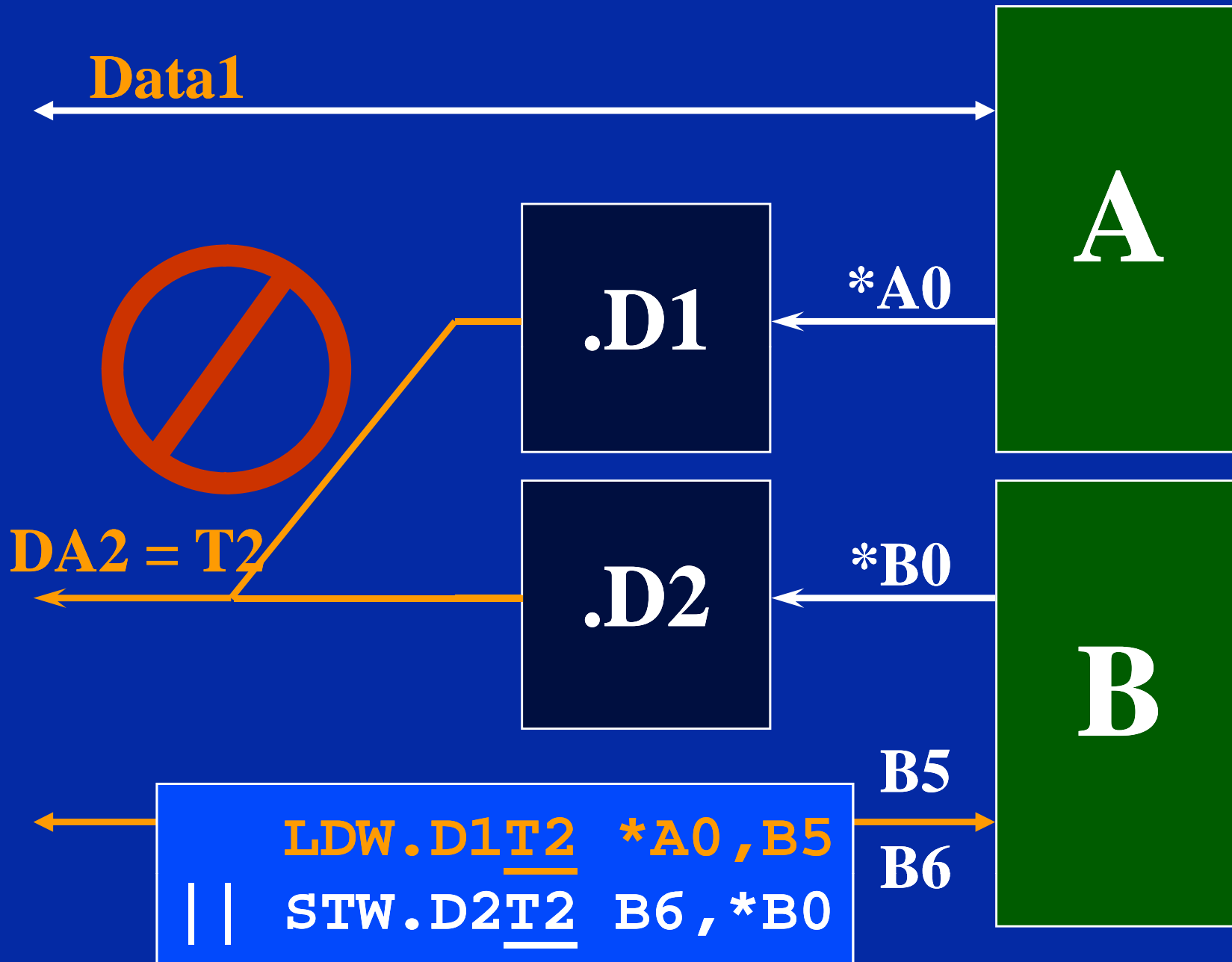

Not Allowed!

Parallel accesses: both cross or neither cross

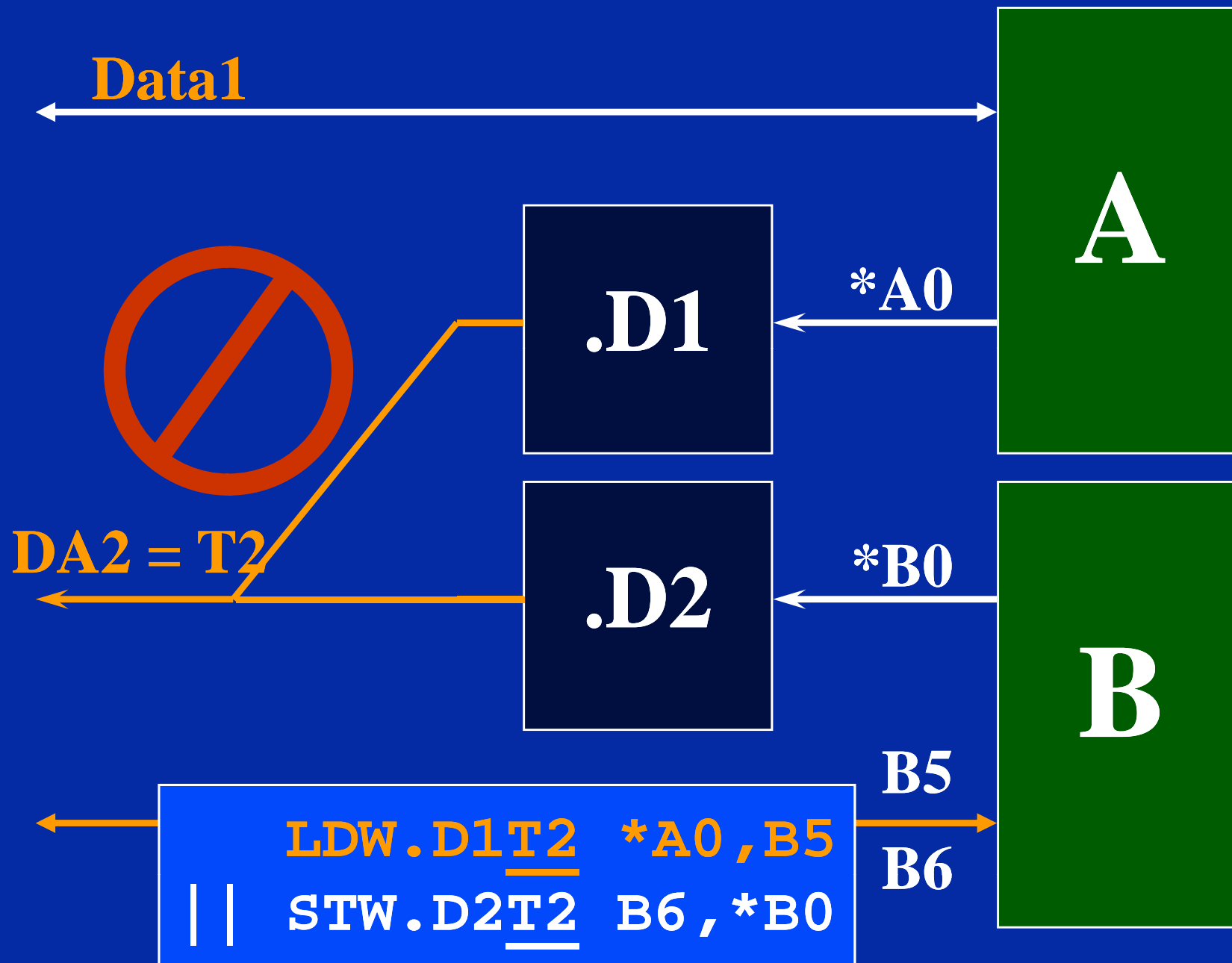

Conditions Don't Use Cross Paths

- ◆ If a conditional register comes from the opposite side, it does **NOT** use a data or address cross-path.
- ◆ Examples:

```
[B2]  ADD    .L1  A2,A0,A4
[A1]  LDW    .D2  *B0,B5
```

'C62x Data-Path Summary

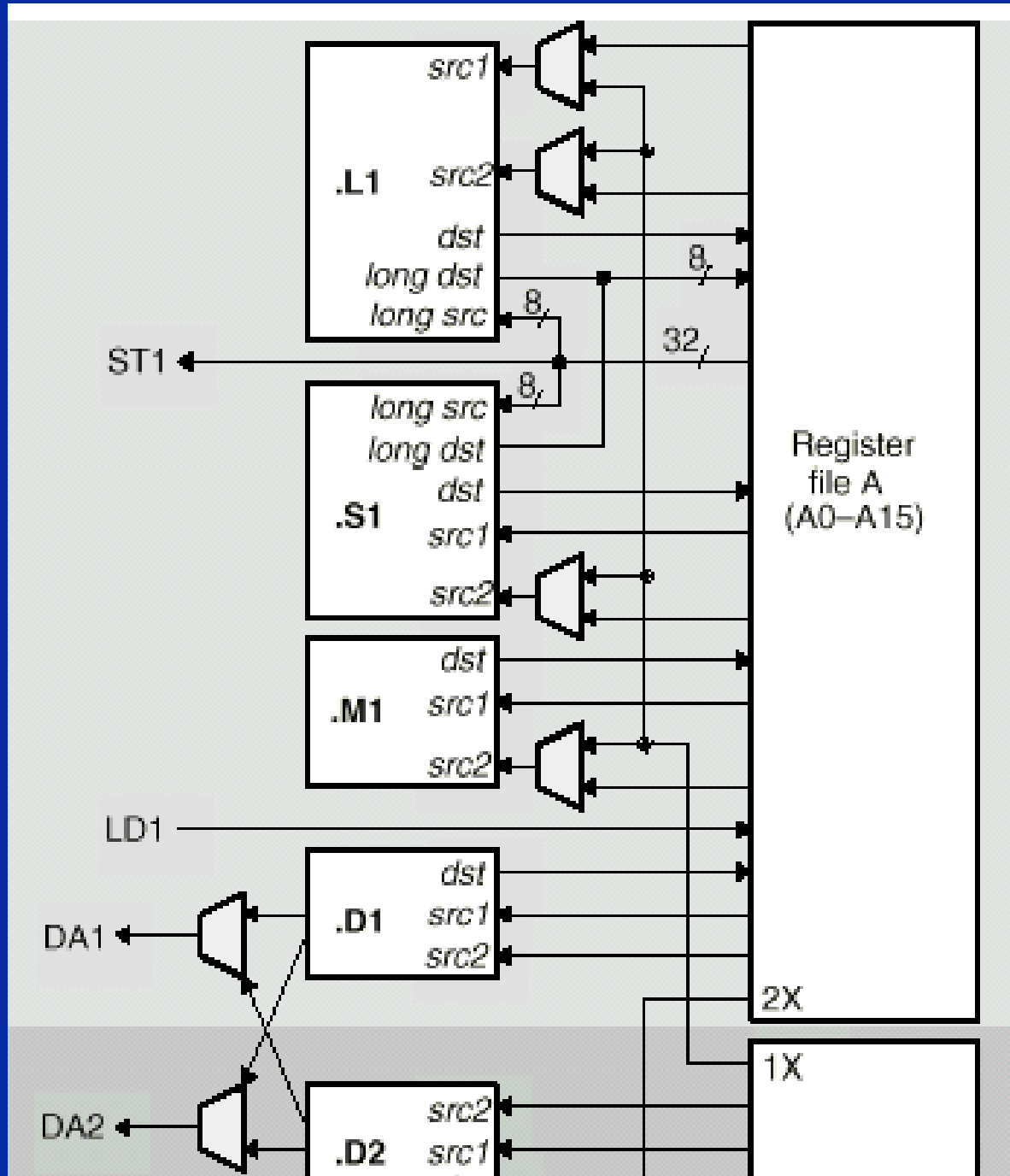

CPU
Ref Guide

Full CPU Datapath
(Pg 2-2)

'C67x Data-Path Summary

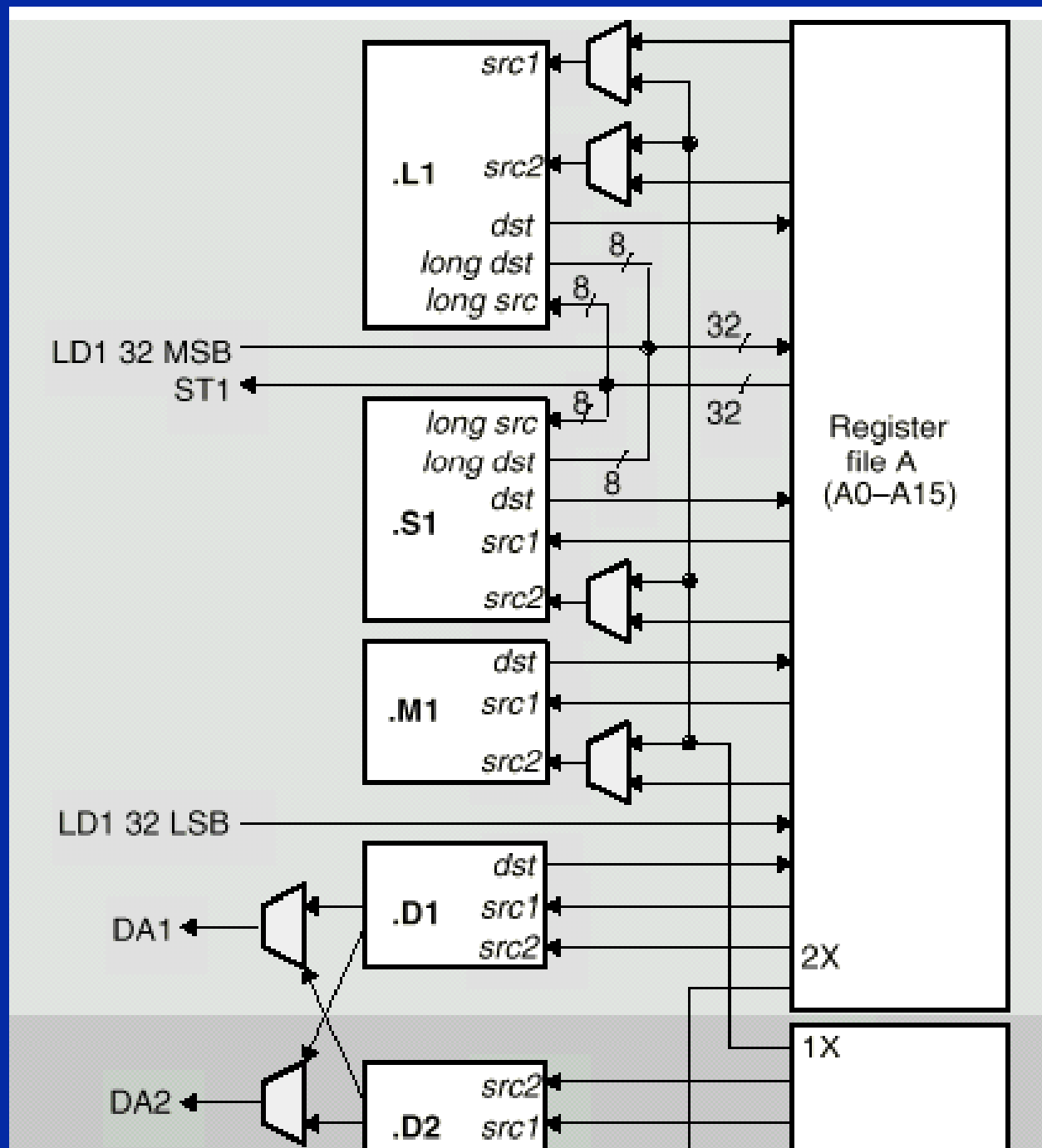
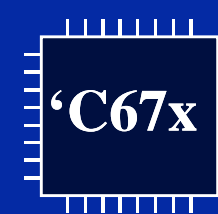

Cross Paths - Summary

✓ Data

- ◆ Destination register on same side as unit.
- ◆ Source registers - up to one cross path per execute packet per side.
- ◆ Use “x” to indicate cross-path.

✓ Address

- ◆ Pointer must be on same side as unit.
- ◆ Data can be transferred to/from either side.
- ◆ Parallel accesses: both cross or neither cross.

✓ Conditionals Don't Use Cross Paths.

Code Review (using side A only)

$$Y = \sum_{n=1}^{40} a_n * x_n$$

```
MVK .S1 40, A2 ; A2 = 40, loop count
loop: LDH .D1 *A5++, A0 ; A0 = a(n)
      LDH .D1 *A6++, A1 ; A1 = x(n)
      MPY .M1 A0, A1, A3 ; A3 = a(n) * x(n)
      ADD .L1 A3, A4, A4 ; Y = Y + A3
      SUB .L1 A2, 1, A2 ; decrement loop count
[A2] B .S1 loop ; if A2 ≠ 0, branch
      STH .D1 A4, *A7 ; *A7 = Y
```

Note: Assume that A4 was previously cleared and the pointers are initialised.

Let us have a look at the final details concerning the functional units.

Consider first the case of the .L and .S units.

Operands - 32/40-bit Register, 5-bit Constant

- ◆ **Operands can be:**
 - ◆ **5-bit constants (or 16-bit for MVKL and MVKH).**
 - ◆ **32-bit registers.**
 - ◆ **40-bit Registers.**
- ◆ **However, we have seen that registers are only 32-bit.**

So where do the 40-bit registers come from?

Operands - 32/40-bit Register, 5-bit Constant

- ◆ A 40-bit register can be obtained by concatenating two registers.
- ◆ However, there are 3 conditions that need to be respected:
 - ◆ The registers must be from the same side.
 - ◆ The first register must be even and the second odd.
 - ◆ The registers must be consecutive.

Operands - 32/40-bit Register, 5-bit Constant

- ◆ All combinations of 40-bit registers are shown below:

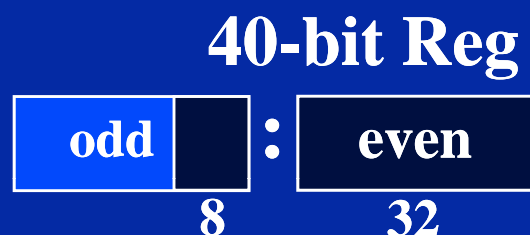

A1 : A0

A3 : A2

A5 : A4

A7 : A6

A9 : A8

A11 : A10

A13 : A12

A15 : A14

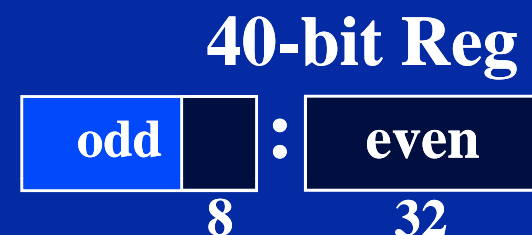

B1 : B0

B3 : B2

B5 : B4

B7 : B6

B9 : B8

B11 : B10

B13 : B12

B15 : B14

Operands - 32/40-bit Register, 5-bit Constant

```
instr .unit <src>, <src>, <dst>
```

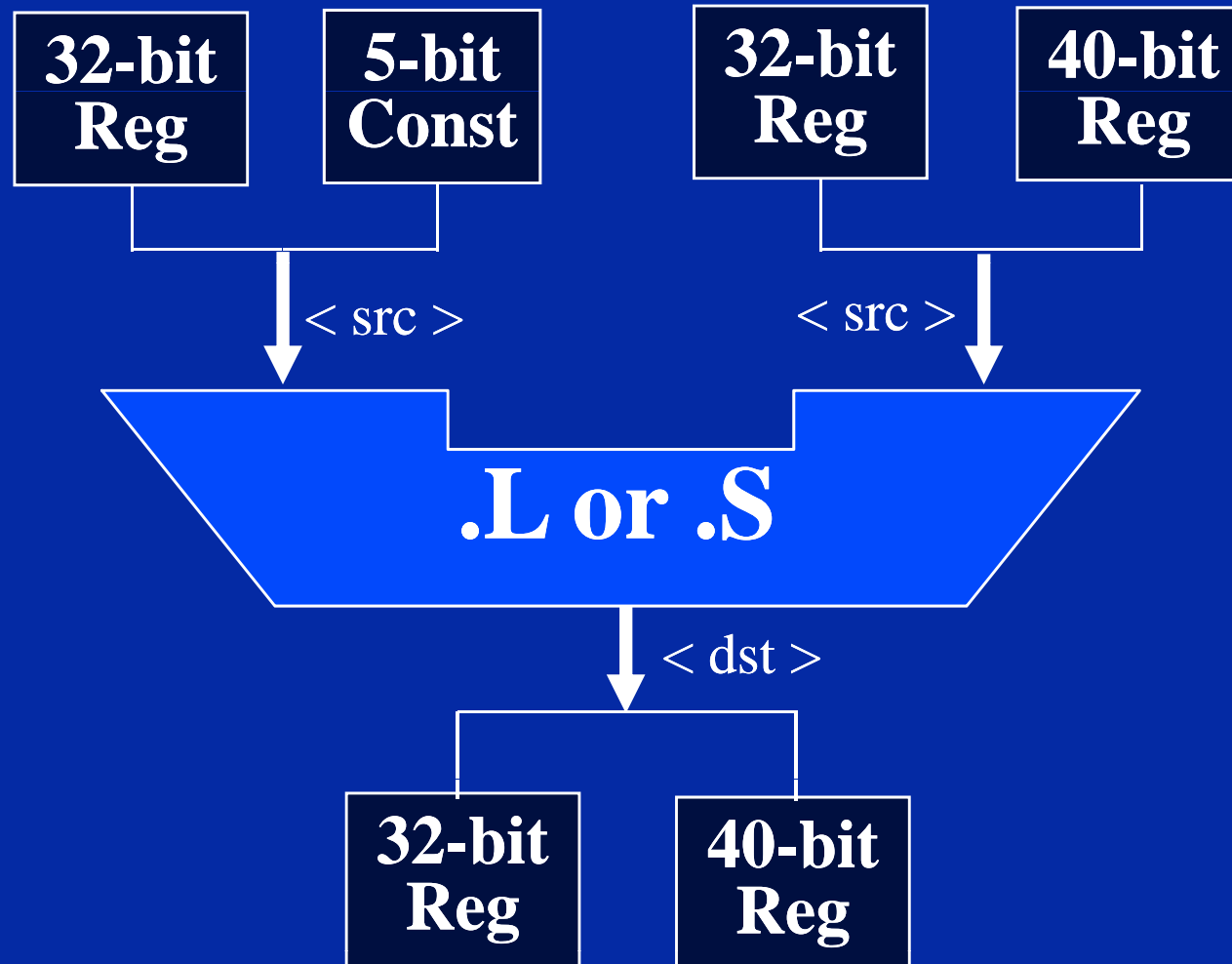

Operands - 32/40-bit Register, 5-bit Constant

```
instr .unit <src>, <src>, <dst>
```

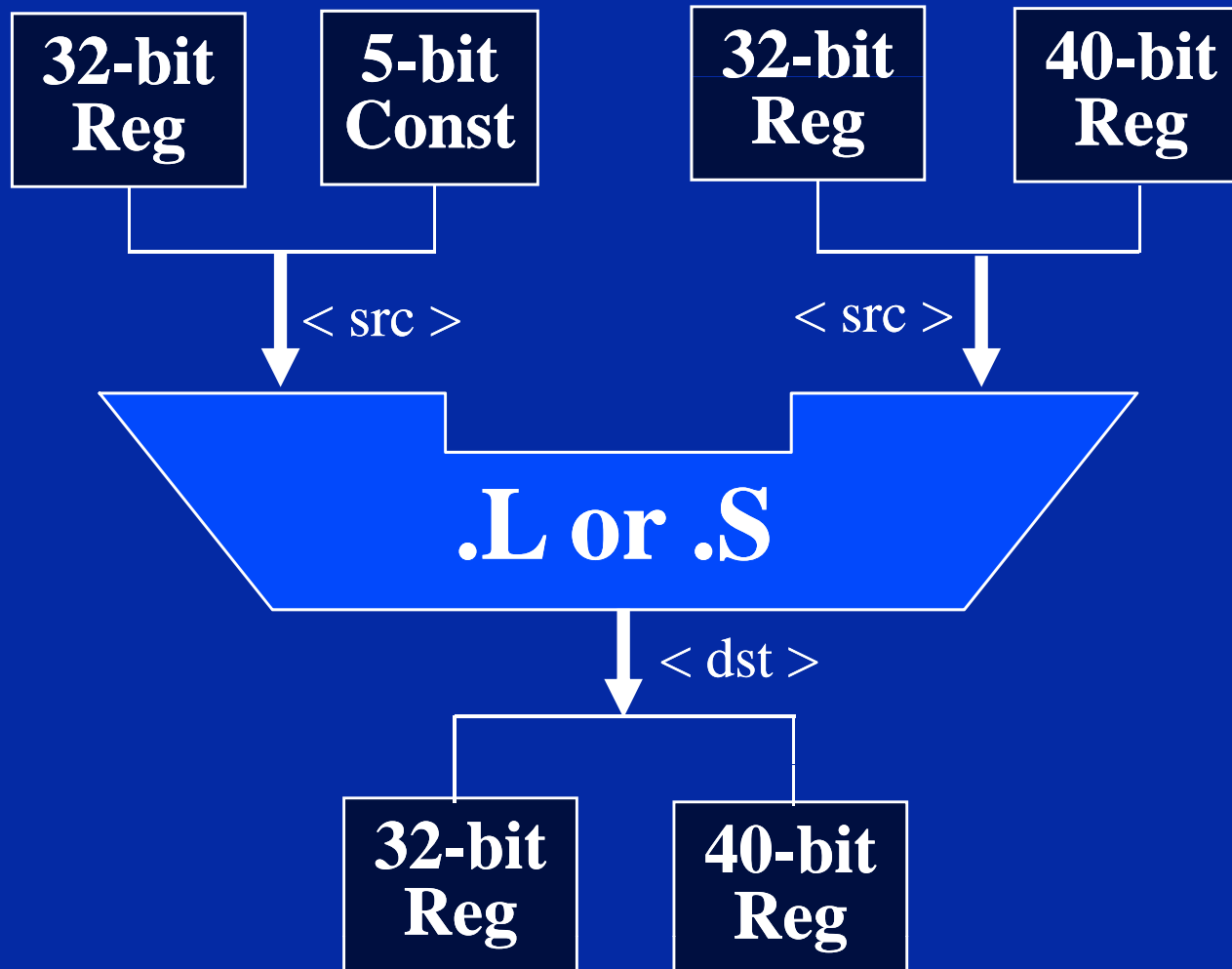

Operands - 32/40-bit Register, 5-bit Constant

```
instr .unit <src>, <src>, <dst>
```

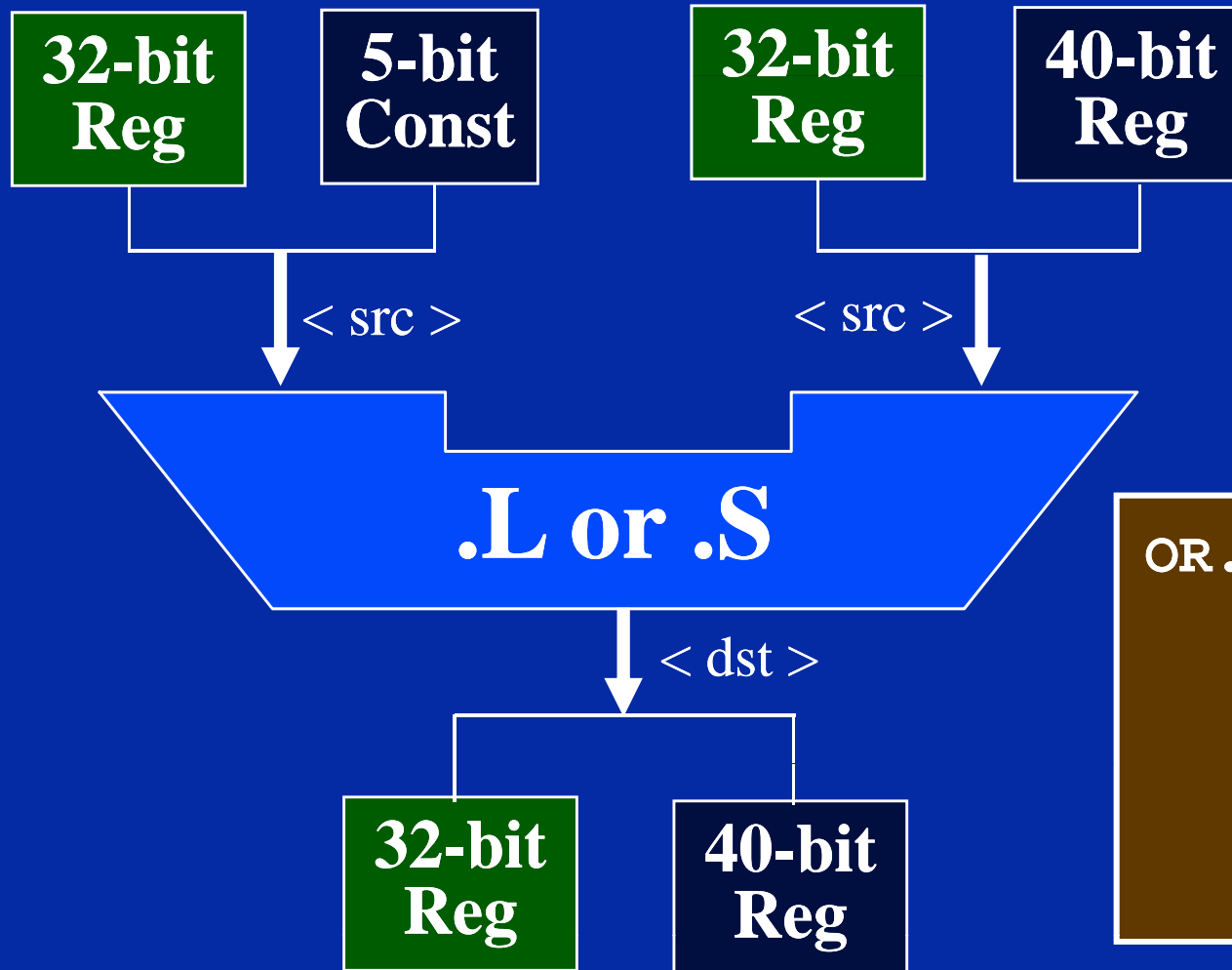

```
OR.L1 A0, A1, A2
```

Operands - 32/40-bit Register, 5-bit Constant

```
instr .unit <src>, <src>, <dst>
```

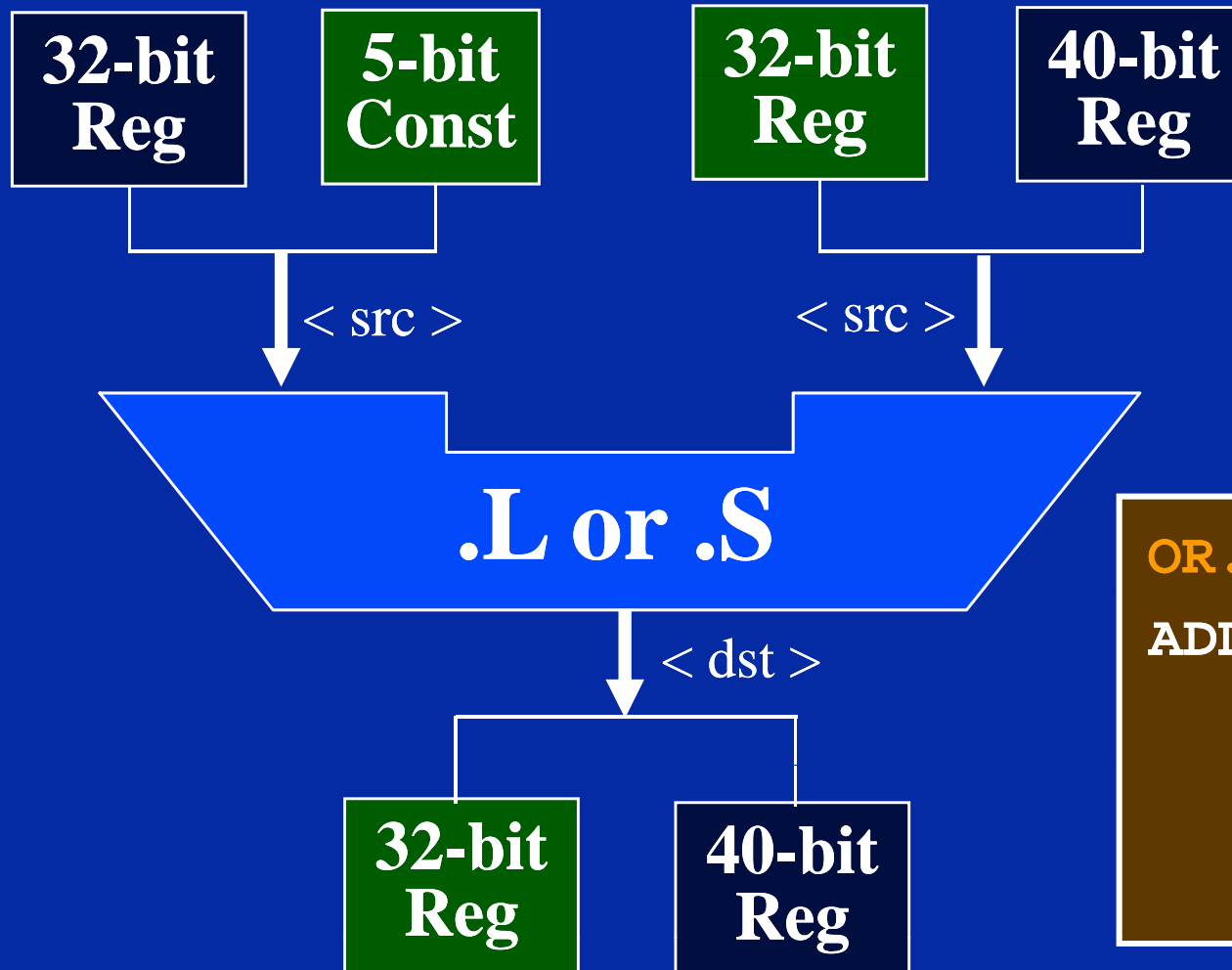

```
OR.L1    A0, A1, A2  
ADD.L2   -5, B3, B4
```

Operands - 32/40-bit Register, 5-bit Constant

```
instr .unit <src>, <src>, <dst>
```

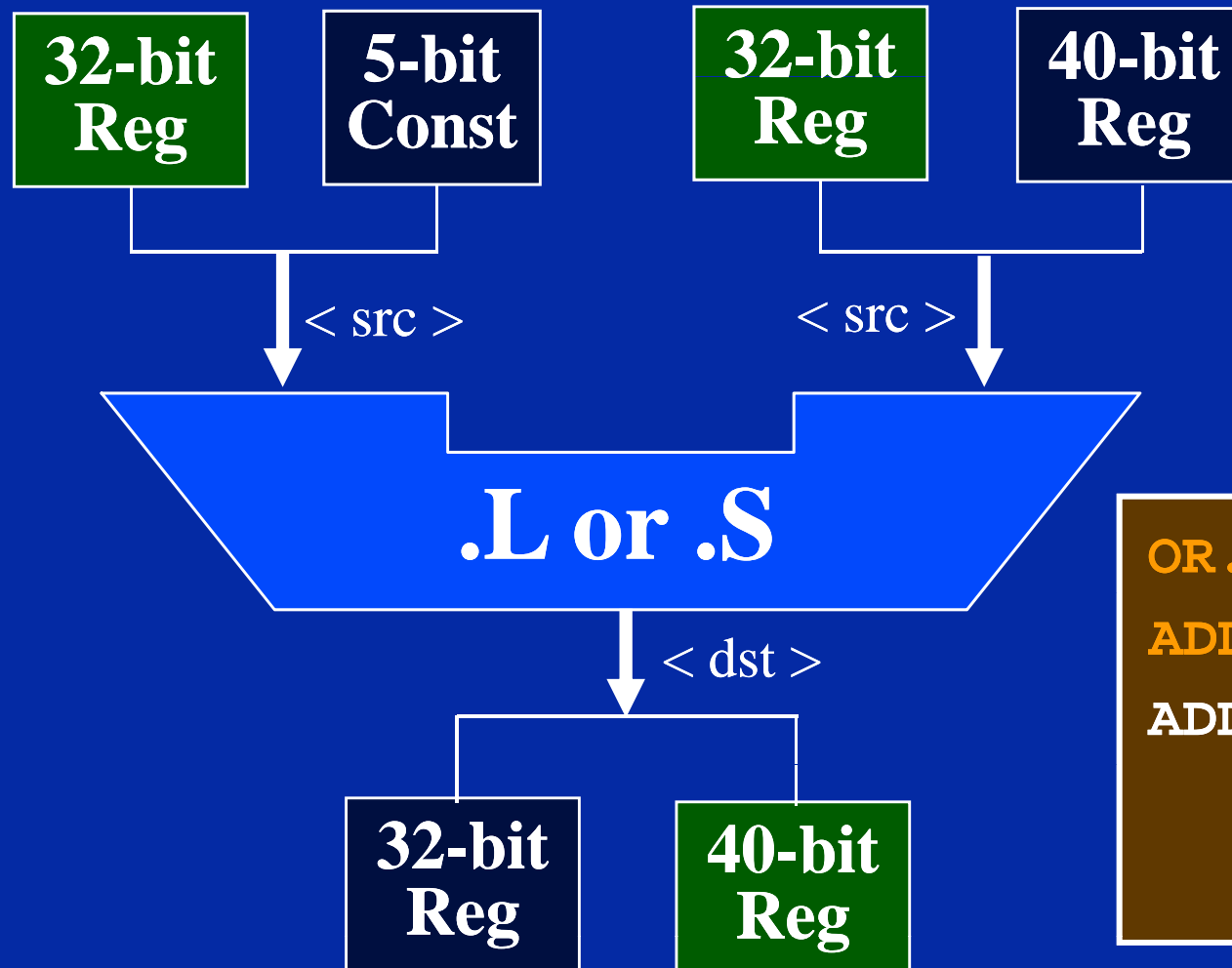

```
OR.L1    A0, A1, A2  
ADD.L2   -5, B3, B4  
ADD.L1   A2, A3, A5:A4
```

Operands - 32/40-bit Register, 5-bit Constant

```
instr .unit <src>, <src>, <dst>
```

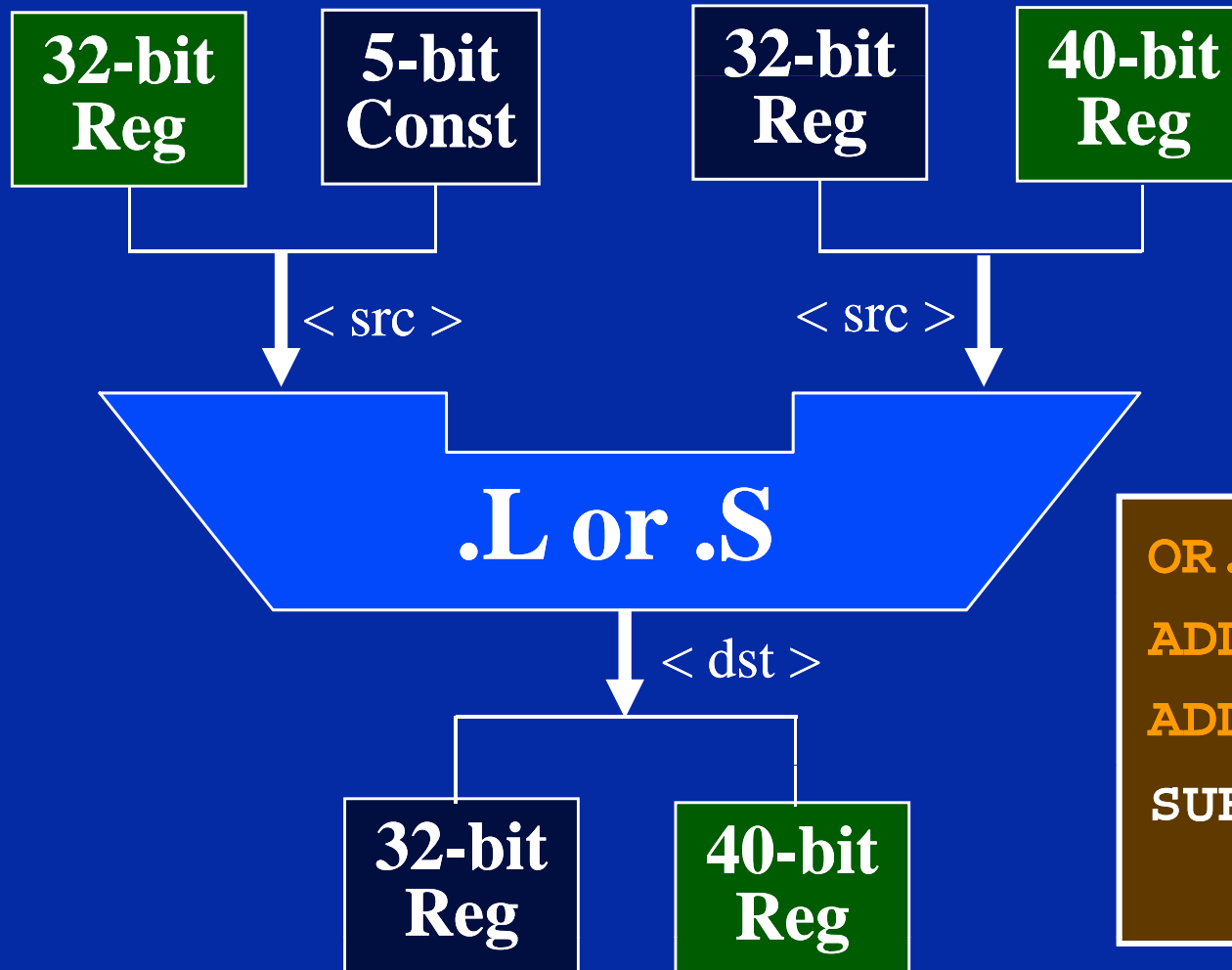

```
OR.L1    A0, A1, A2  
ADD.L2   -5, B3, B4  
ADD.L1   A2, A3, A5:A4  
SUB.L1   A2, A5:A4, A5:A4
```

Operands - 32/40-bit Register, 5-bit Constant

```
instr .unit <src>, <src>, <dst>
```

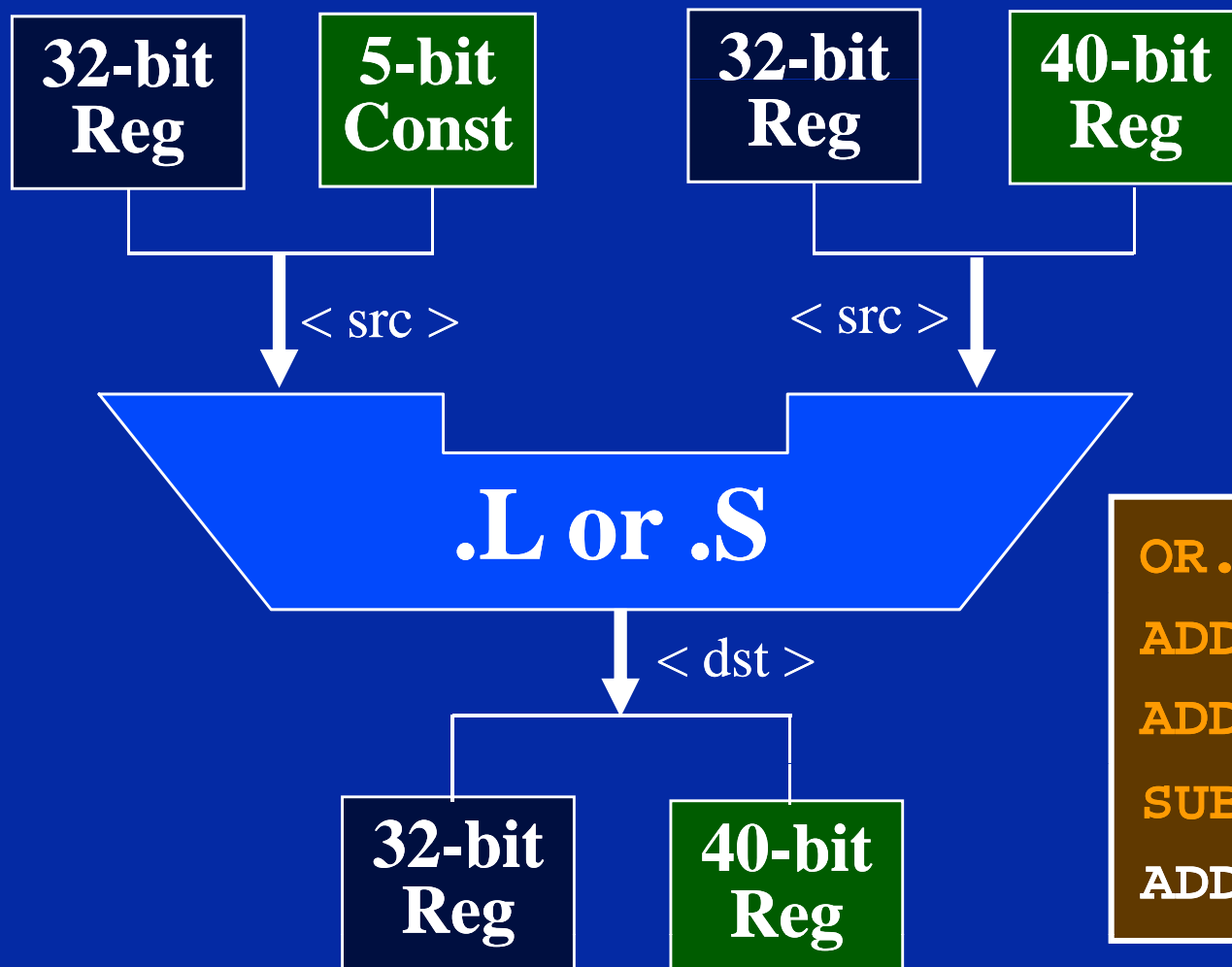

```
OR.L1    A0, A1, A2
ADD.L2   -5, B3, B4
ADD.L1   A2, A3, A5:A4
SUB.L1   A2, A5:A4, A5:A4
ADD.L2   3, B9:B8, B9:B8
```

Register to register data transfer

- ◆ To move the content of a register (A or B) to another register (B or A) use the move “**MV**” Instruction, e.g.:

MV A0, B0

MV B6, B7

- ◆ To move the content of a control register to another register (A or B) or vice-versa use the **MVC** instruction, e.g.:

MVC IFR, A0

MVC A0, IRP

TMS320C6211/6711 Instruction Set

'C6211 Instruction Set (by category)

Arithmetic

ABS
ADD
ADDA
ADDK
ADD2
MPY
MPYH
NEG
SMPY
SMPYH
SADD
SAT
SSUB
SUB
SUBA
SUBC
SUB2
ZERO

Logical

AND
CMPEQ
CMPGT
CMPLT
NOT
OR
SHL
SHR
SSHL
XOR

Bit Mgmt

CLR
EXT
LMBD
NORM
SET

Data Mgmt

LDB/H/W
MV
MVC
MVK
MVKL
MVKH
MVKLH
STB/H/W

Program Ctrl

B
IDLE
NOP

Note: Refer to the 'C6000 CPU Reference Guide for more details.

'C6211 Instruction Set (by unit)

.S Unit	
ADD	MVKLH
ADDK	NEG
ADD2	NOT
AND	OR
B	SET
CLR	SHL
EXT	SHR
MV	SSHL
MVC	SUB
MVK	SUB2
MVKL	XOR
MVKH	ZERO

.L Unit	
ABS	NOT
ADD	OR
AND	SADD
CMPEQ	SAT
CMPGT	SSUB
CMPLT	SUB
LMBD	SUBC
MV	XOR
NEG	ZERO
NORM	

.M Unit	
MPY	SMPY
MPYH	SMPYH

.D Unit	
ADD	STB/H/W
ADDA	SUB
LDB/H/W	SUBA
MV	ZERO
NEG	

Other	
NOP	IDLE

Note: Refer to the 'C6000 CPU Reference Guide for more details.

'C6711 Additional Instructions (by unit)

.S Unit	
ABSSP	CMPLTDP
ABSDP	RCPSP
CMPGTSP	RCPDP
CMPEQSP	RSQRSP
CMPLTSP	RSQRDP
CMPGTDP	SPDP
CMPEQDP	

.M Unit	
MPYSP	MPYI
MPYDP	MPYID

.L Unit	
ADDDP	INTSP
ADDSP	INTSPU
DPINT	SPINT
DPSP	SPTRUNC
INTDP	SUBSP
INTDPU	SUBDP

.D Unit	
ADDAD	LDDW



Note: Refer to the 'C6000 CPU Reference Guide for more details.

TMS320C6211/6711 Memory Map

'C6211 Memory Map

Byte Address

0000_0000

64K x 8 Internal
(L2 cache)

0180_0000

On-chip Peripherals

8000_0000

① 256M x 8 External

9000_0000

① 256M x 8 External

A000_0000

② 256M x 8 External

B000_0000

③ 256M x 8 External

FFFF_FFFF

External Memory

- ◆ Async (SRAM, ROM, etc.)
- ◆ Sync (SBSRAM, SDRAM)

Internal Memory

- ◆ Unified (data or prog)
- ◆ 4 blocks - each can be RAM or cache

Level 1 Cache

- ◆ 4KB Program
- ◆ 4KB Data
- ◆ Not in map

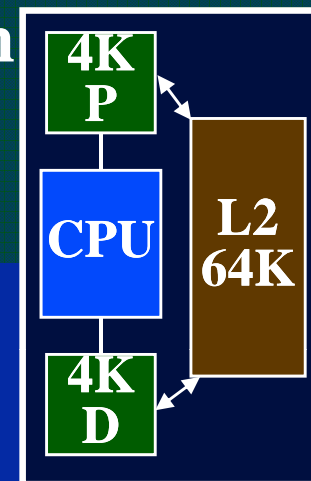

TMS320C6211/6711 Peripherals

'C6x System Block Diagram

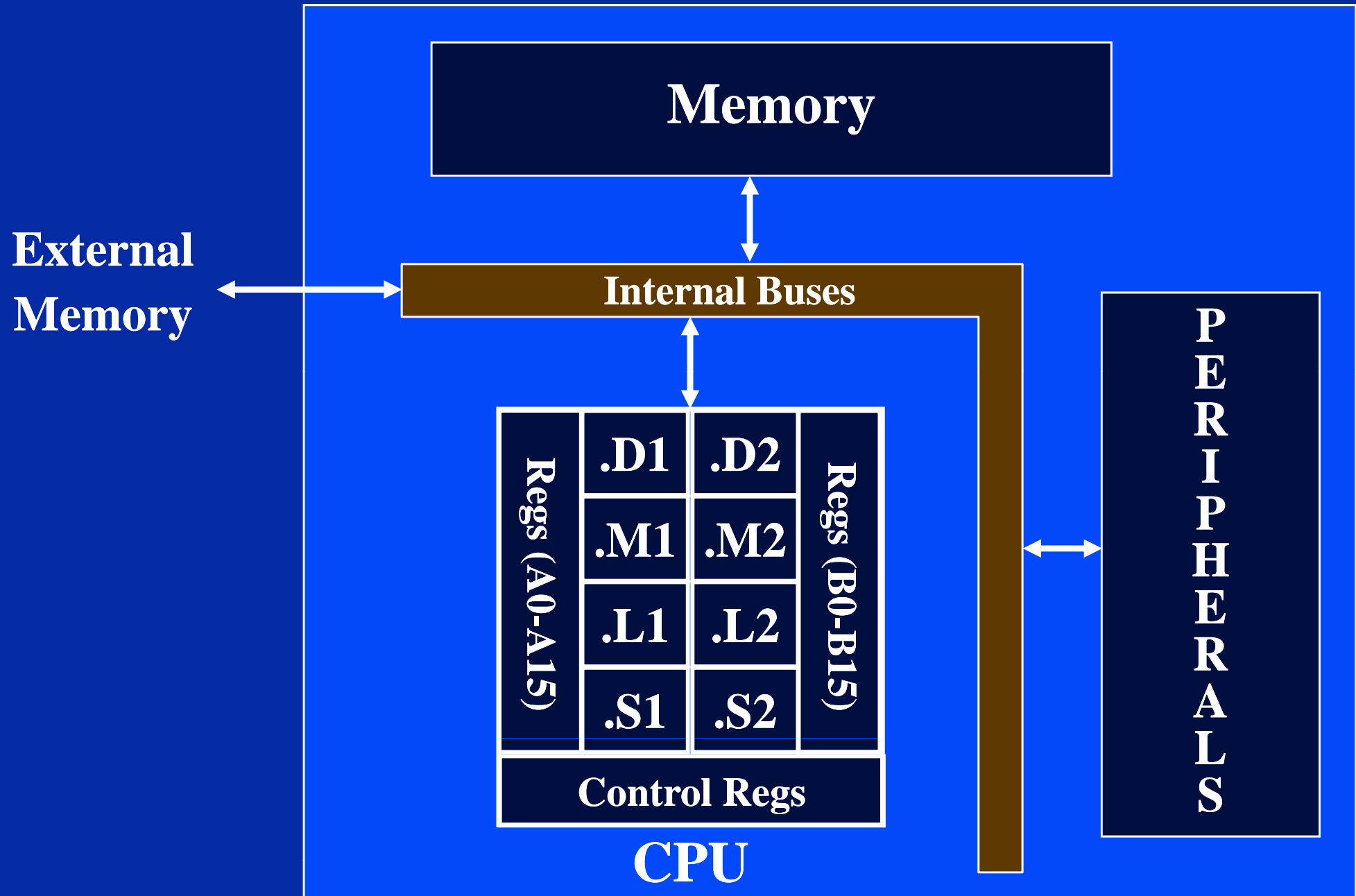

'C6x Internal Buses

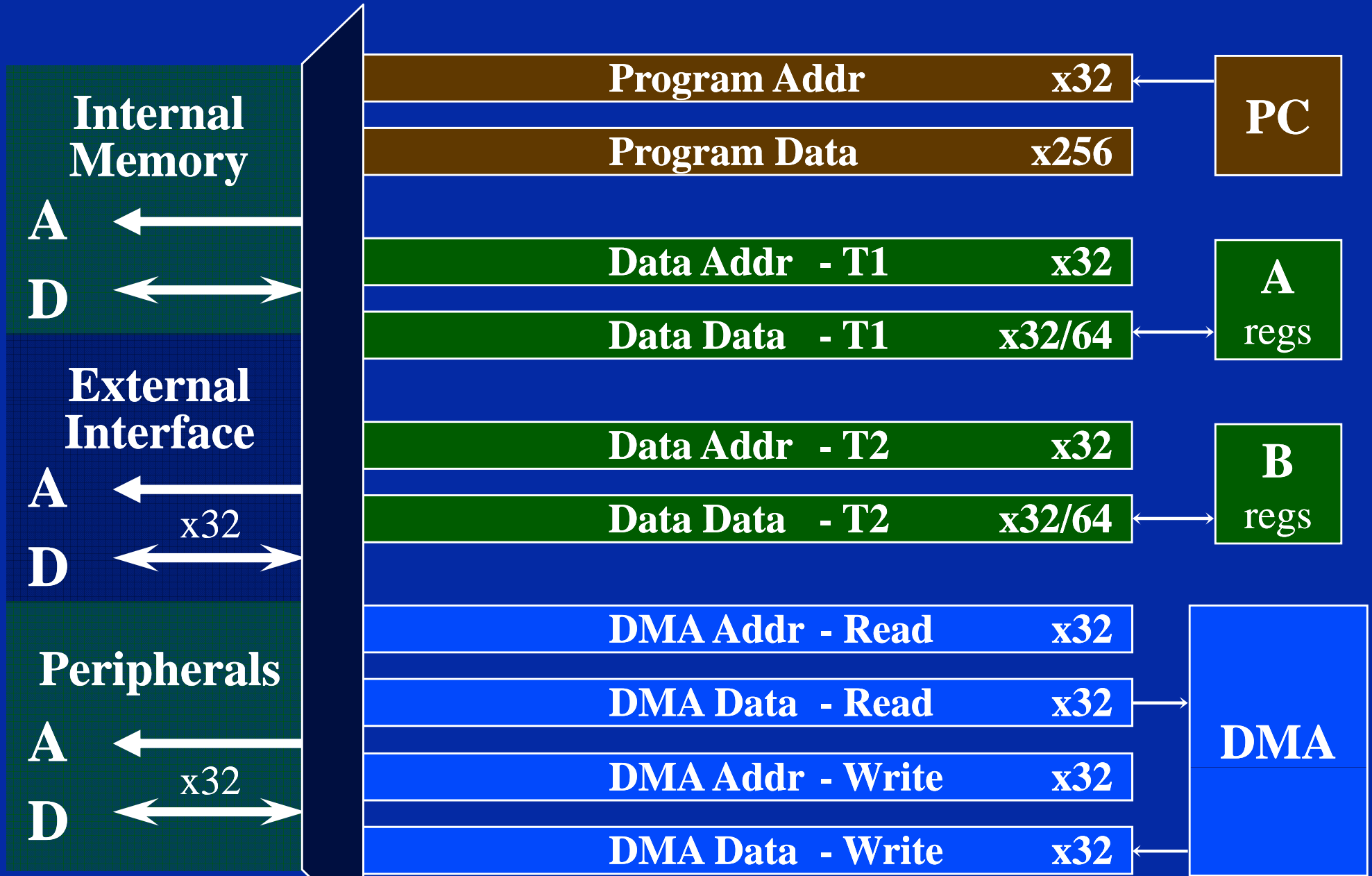

'C67x can perform 64-bit data loads.

'C6x System Block Diagram

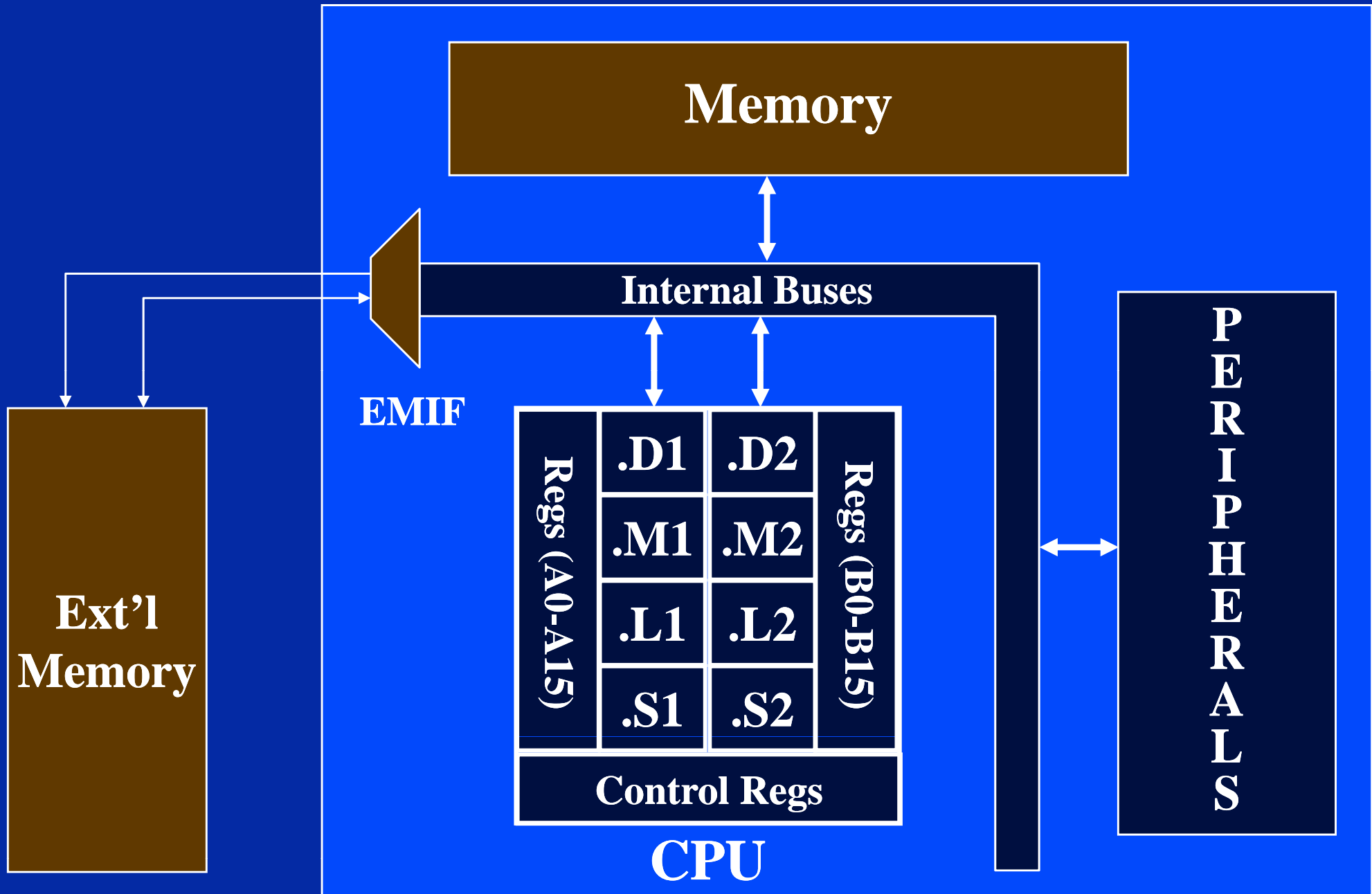

'C6201/11 Memory Maps

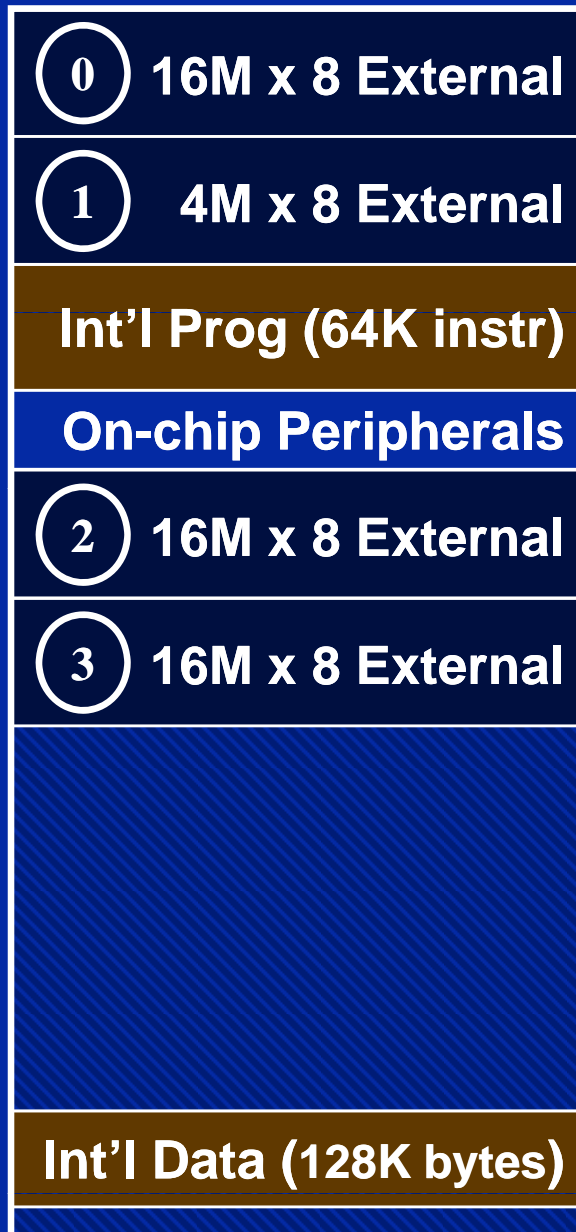

'C6202



'C6211

'C6x System Block Diagram

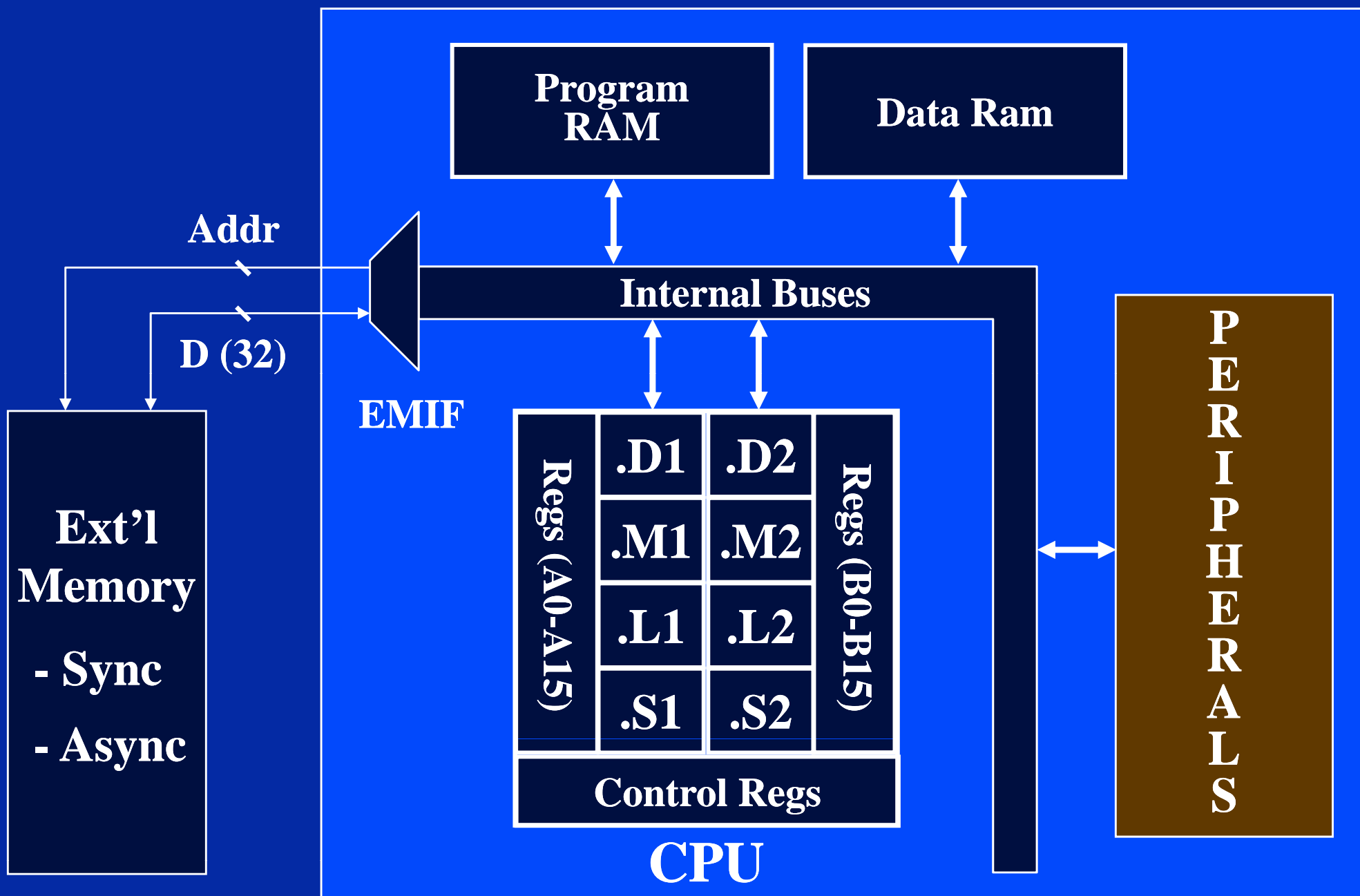

'C6x Peripherals

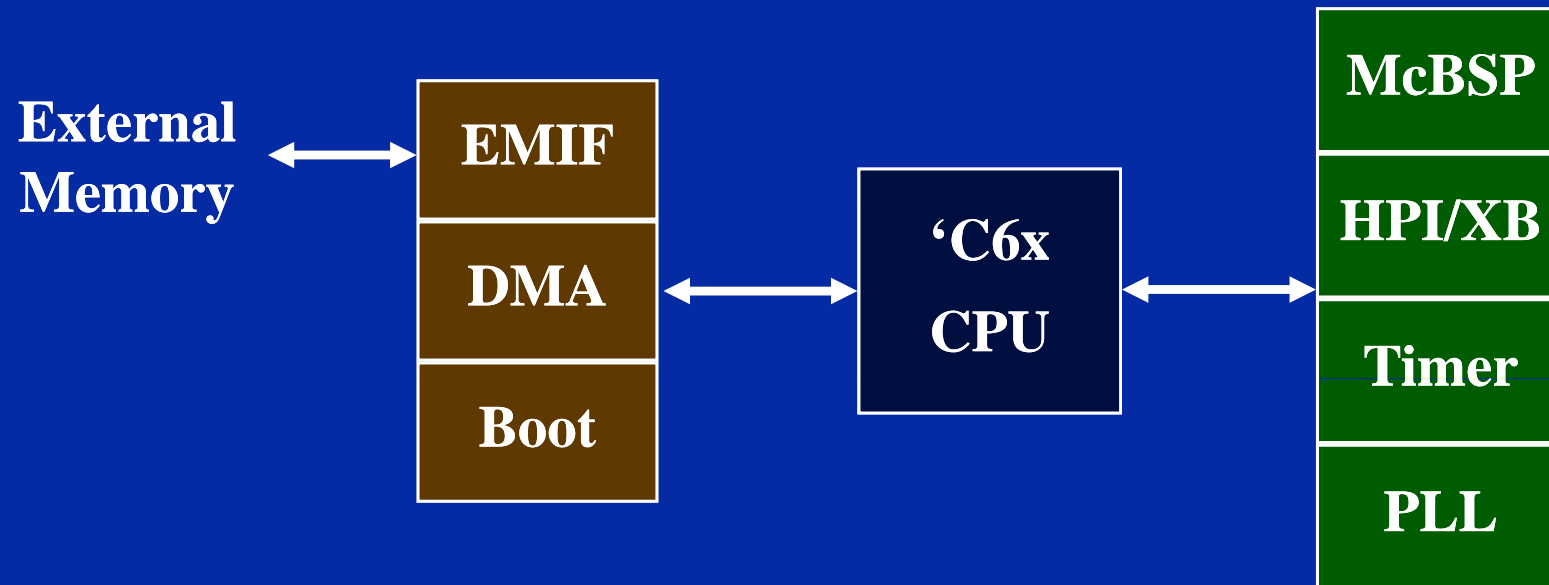

EMIF (External Memory Interface)

- Glueless access to async/sync memory
EPROM, SRAM, SDRAM, SBSRAM

DMA/EDMA (Enhance Direct Memory Acces)

- 4/16 Channels

BOOT

- Boot from 4M external block
- Boot from HPI/XB

McBSP (Multi-Channel Buffered Serial Port)

- High speed sync serial comm
- T1/E1/MVIP interface

HPI (Host Port Interface) /Expansion Bus (XB)

- 16/32-bit host μ P access

Timer/Counters

- Two 32-bit Timer/Counters

Clocking - Basic Definitions

What is a “clock cycle”?

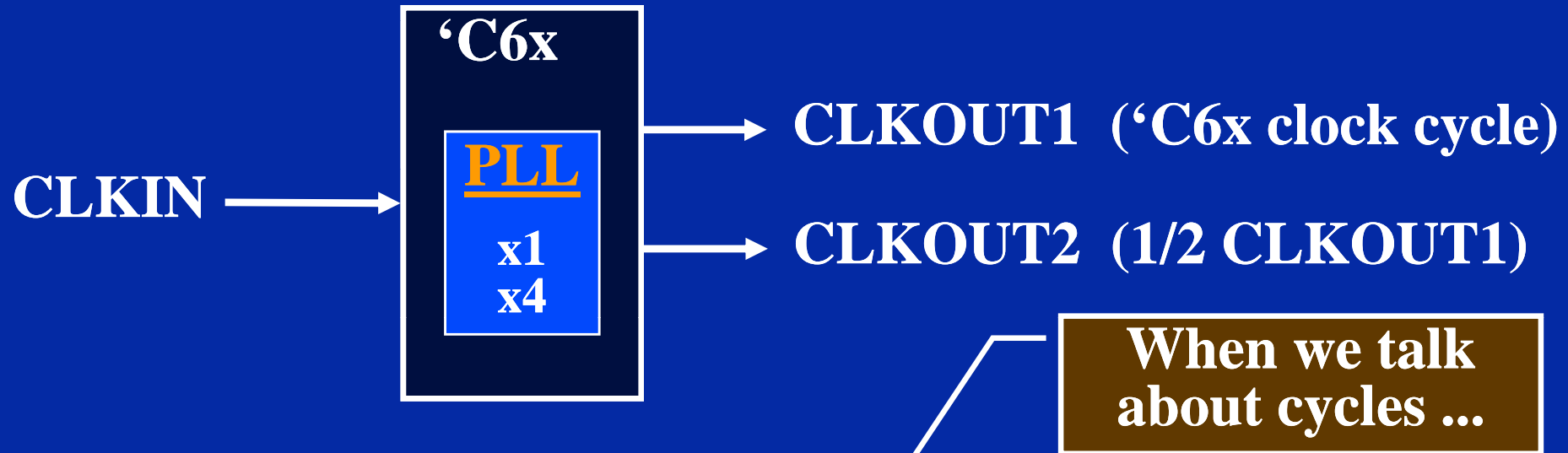

<u>CLKIN - MHz</u>	<u>PLL</u>	<u>CLKOUT1 - MHz</u>	<u>CLKOUT2 - MHz</u>	<u>MIPs (max)</u>
250	x1	250 (4ns)	125	2000
200	x1	200 (5ns)	100	1600
50	x4	200	100	1600
25	x4	100 (10ns)	50	800

'C6x System Block Diagram (Final)

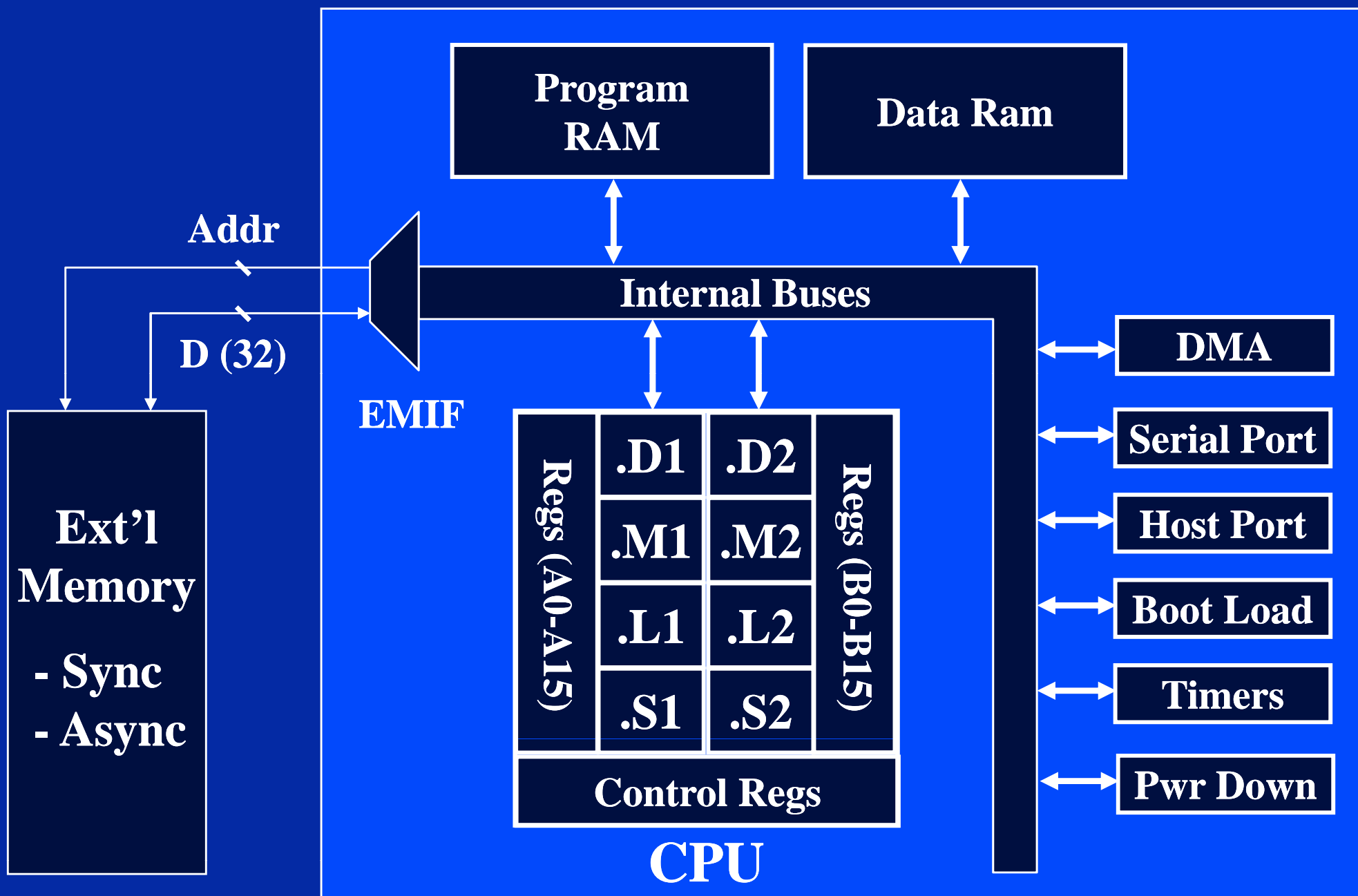

Internal Memory Summary

	L1 Memory		L2 Memory
	Program Memory	Data Memory	
'C6201B	64KB 1 blk Pgm/Cache	64KB 2 blks 4 banks ea	External
'C6701	64KB 1 blk Pgm/Cache	64KB 2 blks 8 banks ea	External
'C6202	256KB 1 blk Pgm/Cache 1 blk Mapped Pgm	128 KB 2 blks 4 banks ea	External
'C6211/C6711	4 KB 1 blk Cache	4 KB 1 blk Cache	64 KB 4 blk Mapped Cache

TMS320C62x DSP Generation

Parametric Table

TMS320C64x DSP Generation

Parametric Table

TMS320C67x DSP Generation

Parametric Table

'C6000 Device Summary

Device	MIPS	MHz	Kbytes	pins	mm	W	\$	Periphs
6201B	1600	200	128	352	27	1.9	80-110	D2H
6202	2000	250	384	352	27	1.9	120-150	D3X
6211	1200	150	72	256	27	1.5	20-40	E2H

TMS320	MFLOPS	MHz	Kbytes	pins	mm	W	\$	Periphs
6701	1000	167	128	352	35	1.9	170-200	D2H
6711	600	100	72	256	27	0.9	20-40	E2H

Peripherals Legend:

D,E: DMA,EDMA
2,3: # of McBSPs
H,X: HPI, XBUS

TMS320C62x DSP Generation
Parametric Table

TMS320C67x DSP Generation
Parametric Table

TMS320C64x DSP Generation
Parametric Table

'C6000 History

- 6201 r1** 1Q97 coincident 'C6x architectural announcement. Sample CPU core, minimal peripherals.
- 6201 r2** 4Q97. Full production, with peripherals.
- 6201B** 4Q98. Power reduced, .18 micron silicon, double ports into internal data memory.
- 6701** 3Q98. Pin-for-pin compatible floating-point version of 'C6201. 1GFLOP (@ 167MHz) performance.
- 6202** 2Q99. 2000 MIPS @ 250MHz. 2-3x 6201 on-chip memory. Replaced HPI with Expansion Bus (32-bit HPI + more).
- 6211** 3Q99. 2 cents per MIPS! 1200MIPS @ 150MHz as low as \$25. Double-level cache, enhanced DMA.
- 6711** Announced 3/1/99. 6701 floating-point CPU with 6211-like memory/peripherals. Volume pricing under \$20.

'C6x Family Part Numbering

◆ Example = TMS320LC6201PKG A200

- ◆ TMS320 = TI DSP
- ◆ L = Place holder for voltage levels
- ◆ C6 = C6x family
- ◆ 2 = Fixed-point core
- ◆ 01 = Memory/peripheral configuration
- ◆ PKG = Pkg designator (actual letters TBD)
- ◆ A = -40 to 85C (blank for 0 to 70C)
- ◆ 200 = Core CPU speed in Mhz

Device Summary Table

Device	Int Mem	Ext Mem	Peripherals
6201/6701	64K Data 16K Instr	3 x 16M 1 x 4M	DMA 2 McBSP HPI (16-bit) 2 Timer/Counters (32-bit)
6202	128K Data 48K Instr	3 x 16M 1 x 4M 4 x 256M ----	DMA 2 McBSP XBus (32-bit) 2 Timer/Counters (32-bit)
6211	4K Data Cache 4K Prog Cache 64K RAM/Cache	4 x 256M	EDMA 2 McBSP HPI (16-bit) 2 Timer/Counters (32-bit)

Module 1 Exam

1. Functional Units

a. How many can perform an ADD? Name them.

six; .L1, .L2, .D1, .D2, .S1, .S2

b. Which support memory loads/stores?

.M .S .D .L

2. Memory Map

a. How many external ranges exist on 'C6201?

Four

3. Conditional Code

a. Which registers can be used as cond'l registers?

A1, A2, B0, B1, B2

b. Which instructions can be conditional?

All of them

4. Performance

a. What is the 'C6711 instruction cycle time?

CLKOUT1

b. How can the 'C6711 execute 1200 MIPs?

1200 MIPs = 8 instructions (units) x 150 MHz

5. Coding Problems

a. Move contents of A0-->A1

MV .L1 A0, A1
or ADD .S1 A0, 0, A1
or MPY .M1 A0, 1, A1 (what's the problem with this?)

5. Coding Problems

a. Move contents of A0-->A1

```
MV .L1 A0, A1
or  ADD .S1 A0, 0, A1
or  MPY .M1 A0, 1, A1
```

(A0 can only be a
16-bit value)

b. Move contents of CSR-->A1

```
MVC CSR, A1
```

c. Clear register A5

```
ZERO .S1 A5
or  SUB .L1 A5, A5, A5
or  MPY .M1 A5, 0, A5
or  CLR .S1 A5, 0, 31, A5
or  MVK .S1 0, A5
or  XOR .L1 A5, A5, A5
```

5. Coding Problems (cont'd)

d. $A2 = A0^2 + A1$

```
MPY.M1    A0, A0, A2
ADD.L1    A2, A1, A2
```

e. If $(B1 \neq 0)$ then $B2 = B5 * B6$

```
[B1] MPY.M2    B5, B6, B2
```

f. $A2 = A0 * A1 + 10$

```
MPY       A0, A1, A2
ADD       10, A2, A2
```

g. Load an *unsigned* constant (19ABCh) into register A6.

```
mvkl .s1 0x00019abc, a6
mvkh .s1 0x00019abc, a6
```

```
value .equ    0x00019abc
mvkl.s1 value, a6
mvkh.s1 value, a6
```

5. Coding Problems (cont'd)

- h. Load A7 with contents of mem1 and post-increment the selected pointer.

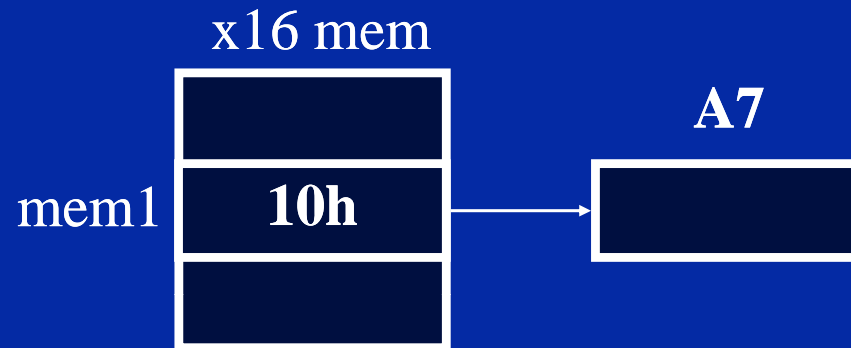

```
load_mem1:    MVKL    .S1    mem1,    A6
              MVKH    .S1    mem1,    A6
              LDH     .D1    *A6++,   A7
```

Architecture

◆ Links:

- ◆ C6711 data sheet: [tms320c6711.pdf](#)
- ◆ User guide: [spru189f.pdf](#)
- ◆ Errata: [sprz173c.pdf](#)

Chapter 2
TMS320C6000 Architectural
Overview

- End -